



QuickScan™ Mobile



Reference Manual

Datalogic Scanning, Inc.
959 Terry Street
Eugene, Oregon 97402
USA
Telephone: (541) 683-5700
Fax: (541) 345-7140

An Unpublished Work - All rights reserved. No part of the contents of this documentation or the procedures described therein may be reproduced or transmitted in any form or by any means without prior written permission of Datalogic Scanning, Inc. or its subsidiaries or affiliates ("Datalogic" or "Datalogic Scanning"). Owners of Datalogic products are hereby granted a non-exclusive, revocable license to reproduce and transmit this documentation for the purchaser's own internal business purposes. Purchaser shall not remove or alter any proprietary notices, including copyright notices, contained in this documentation and shall ensure that all notices appear on any reproductions of the documentation.

Should future revisions of this manual be published, you can acquire printed versions by contacting your Datalogic representative. Electronic versions may either be downloadable from the Datalogic website (www.scanning.datalogic.com) or provided on appropriate media. If you visit our website and would like to make comments or suggestions about this or other Datalogic publications, please let us know via the "Contact Datalogic" page.

Disclaimer

Datalogic has taken reasonable measures to provide information in this manual that is complete and accurate, however, Datalogic reserves the right to change any specification at any time without prior notice. Datalogic is a registered trademark of Datalogic S.p.A. in many countries and the Datalogic logo is a trademark of Datalogic S.p.A. all licensed to Datalogic Scanning, Inc. All other trademarks and trade names referred to herein are property of their respective owners.

CONTENTS

1	INTRODUCTION	1
2	INSTALLATION.....	3
3	CONFIGURATION.....	9
	RS-232 PARAMETERS.....	20
	Baud Rate	21
	Parity.....	22
	Data Bits	22
	Stop Bits.....	23
	Handshaking	23
	Ack/Nack Protocol.....	24
	Fifo	24
	Inter-character Delay.....	25
	Rx Timeout.....	25
	Serial Trigger Lock	26
	USB PARAMETERS	27
	Handshaking	28
	Ack/Nack Protocol.....	28
	Fifo	29
	Inter-character Delay.....	29
	Rx Timeout.....	30
	Serial Trigger Lock	30
	Keyboard Nationality	31
	Fifo	32
	Inter-character Delay.....	32
	Inter-code Delay.....	33
	Control Character Emulation.....	33
	USB Keyboard Speed	34
	WEDGE PARAMETERS.....	35
	Keyboard Nationality	36
	Caps Lock	37
	Caps Lock Auto-Recognition (IBM AT compatible only).....	37
	Num Lock	38
	Inter-character Delay.....	38
	Inter-code Delay.....	39
	Keyboard Setting.....	40
	Control Character Emulation.....	42

PEN EMULATION	43
Operating Mode	44
Minimum Output Pulse	45
Conversion to Code 39 and Code 128	46
Overflow	47
Output Level	47
Idle Level	48
Inter-Block Delay	48
 IBM 46xx	 49
IBM Data Formatting	50
 DATA FORMAT	 51
Code Identifier	54
Custom Code Identifier	55
Header	56
Terminator	57
Special Keys	58
Field Adjustment	59
Field Adjustment Character	60
Code Length Tx	60
Character Replacement	61
Address Stamping	63
Address Delimiter	63
 READING PARAMETERS	 64
Hand-Held Operation	65
Stand Operation	65
Hardware Trigger Mode	66
Trigger-off Timeout	66
Flash Mode	67
Reads per Cycle	67
Safety Time	68
Beeper Intensity	68
Beeper Tone	69
Beeper Type	69
Beeper Length	69
Stand Recognition Beep	70
 DECODING PARAMETERS	 71
Ink Spread	72
Overflow Control	72
Interdigit Control	73
Decoding Safety	73
Puzzle Solver™	74

	CODE SELECTION	75
	EAN/UPC Family	77
	2/5 Family	84
	Code 39 Family	85
	Code 128 Family	87
	Code 93	88
	Codabar Family	89
	MSI	91
	Plessey	92
	Telepen	93
	Delta IBM	94
	Code 11	95
	Code 16K	96
	Code 49	96
	GS1 DataBar™	97
	ADVANCED FORMATTING	98
	Concatenation	99
	Advanced Formatting	102
	RADIO PARAMETERS.....	117
	Radio Protocol Timeout.....	118
	Power-Off Timeout	118
	Beeper Control for Radio Response	119
	Single Store	120
	Batch Mode.....	121
4	REFERENCES	122
5	TECHNICAL FEATURES	145
A	HOST CONFIGURATION STRINGS	150
B	CODE IDENTIFIER TABLE	163
C	HEX AND NUMERIC TABLE	166

GENERAL VIEW

QUICKSCAN® MOBILE READERS



1 INTRODUCTION

The QuickScan® family provides a valuable solution for users seeking an affordable handheld device without compromise in performance.

The extensive range of models and options of this family can easily meet any specific challenges required by retail, and commercial data collections applications.

The QuickScan® Mobile is the ideal solution for retail and commercial environments where continuous and multi-tasking activities are keys to optimum productivity, lower cost of ownership and profitable business.

1.1 READING ANGLE

QuickScan® Mobile readers automatically scan barcodes **at a distance**. Simply aim and pull the trigger. Code scanning is performed along the center of the light bar emitted from the reading window. This bar must cover the entire code.

Successful scanning is obtained by tilting the reader with respect to the barcode to avoid direct reflections, which could impair the reading performance. See the figures below.

Successful reading is obtained by an audible tone.

Good read LED



OK

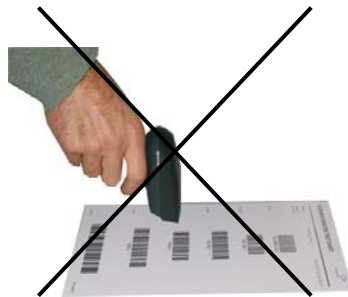

Not Advised

1.2 HANDS-FREE USE

When using the QuickScan® Mobile on the cradle, remember to lock the reader by pushing up the locking system as indicated in the following figure.



2 INSTALLATION

2.1 USING YOUR QUICKSCAN® MOBILE READING SYSTEM

Follow the procedure below to start using your QuickScan® Mobile reading system:

1. Connect a QuickScan® Mobile cradle to the Host.
2. Insert the QuickScan® Mobile reader into the cradle to start the battery charging. A full charge of the Lithium battery takes 3.5 – 6 hours.



*To achieve the best battery life, it is recommended to perform a full battery charge before using the reader **in hand-held mode**.*

NOTE

In hands-free use, you can immediately start using the reader, since it is powered by the cradle.

3. Configure the QuickScan® Mobile reader.
4. Configure the QuickScan® Mobile cradle.

2.2 CHANGING THE BATTERIES

To change the battery of your reader, you must:

1. Unscrew the battery cover screw (Figure 1).
2. Unplug the white connector and remove the old battery (Figure 2).
3. Insert the new battery and plug in the white connector.



When inserting the new battery into the handle pay attention to position the battery and the connector just as shown in Figure 3.

NOTE



Figure 1



Figure 2



Figure 3

4. Insert the cover in the handle and screw it back into place.



Figure 4



WARNING

Do not incinerate, disassemble, short terminals or expose to high temperature. Risk of fire, explosion. Use specified charger only. Risk of explosion if the battery is replaced by an incorrect type. Dispose of the batteries as required by the relevant laws in force.

2.3 SYSTEM CONNECTIONS



CAUTION

Connections should always be made with power OFF!

You can connect the QuickScan® Mobile cradle to the Host through the dedicated connector, using the cable corresponding to the desired interface type.

1. Connect the appropriate interface cable to the cradle by simply plugging it into the Host connector on the base of the cradle.

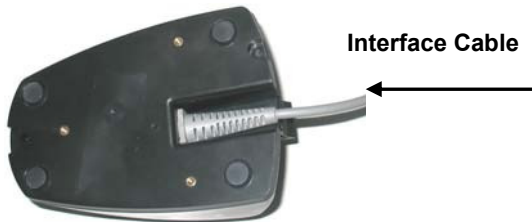

QuickScan® Mobile Cradle - Bottom View

To disconnect the cable, insert a paper clip or other similar object into the hole corresponding to the connector on the base of the cradle. Push down on the clip while unplugging the cable. Refer to the following figure:



Disconnecting the Cable

2.4 RS-232 CONNECTION



2.5 USB



2.6 IBM USB POS

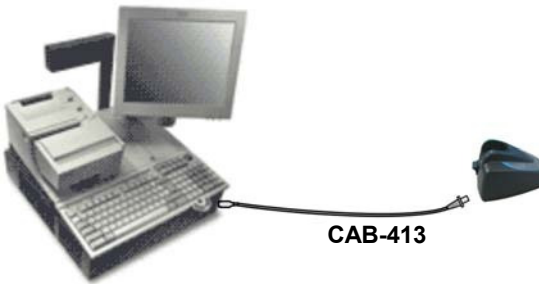

2.7 WEDGE CONNECTION (only for Quickscan M2 Type:130)

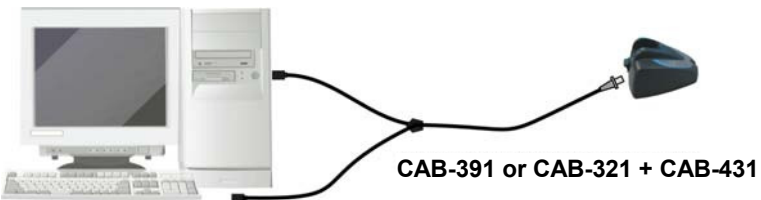

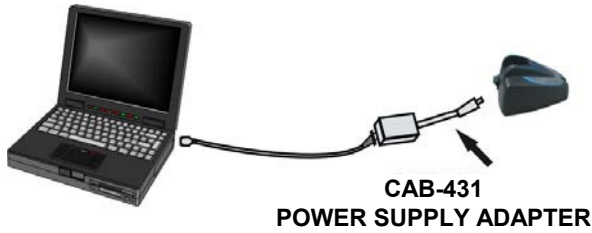

2.8 IBM PORT9B / IBM PORT 5B (only for Quickscan M2 Type:110)



2.9 PEN EMULATION CONNECTION

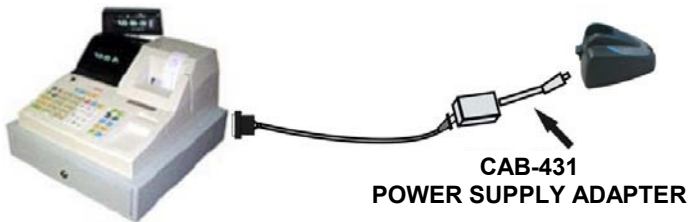

2.10 SINGLE READER LAYOUT

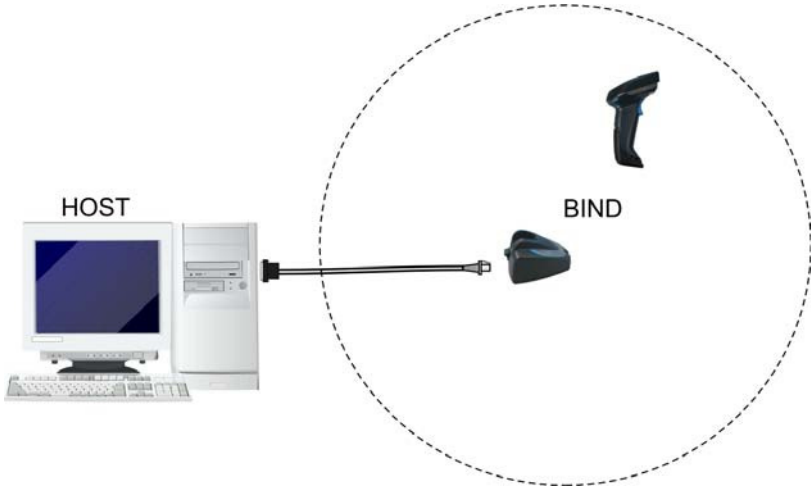

3 CONFIGURATION

3.1 CONFIGURATION METHODS

3.1.1 Reading Configuration Barcodes

This manual can be used for complete setup and configuration of your reader by following the setup procedures in this chapter.

If you wish to change the default settings, this manual provides complete configuration of your reader in an easy way.

To configure your reader:

1. Open the folded page in [Appendix C](#) with the hex-numeric table and keep it open during the device configuration.
2. Read the **Enter Configuration** code ONCE, available at the top of each page of configuration.
3. Modify the desired parameters in one or more sections following the procedures given for each group.
4. Read the **Exit and Save Configuration** code ONCE, available at the top of each page of configuration.

Reference notes describing the operation of the more complex parameters are given in chapter 4.

3.1.2 Datalogic Aladdin™

Datalogic Aladdin™ is a multi-platform utility program that allows device configuration using a PC. It provides RS-232 interface configuration as well as configuration barcode printing.

3.1.3 Copy Command

A previously configured device (Master), can be used to send its configuration directly to other devices of the same type (Slaves). The particular procedure for each device is given.

3.1.4 Sending Configuration Strings from Host

An alternative configuration method is provided in Appendix A using the RS-232 or USB-COM interface. This method is particularly useful when many devices need to be configured with the same settings. Batch files containing the desired parameter settings can be prepared to configure devices quickly and easily.

3.2 QUICKSCAN® MOBILE STAND ALONE SETUP

Read the restore default parameters code below.

1. Restore QuickScan® Mobile Default

2. Read the codes below to set the radio address of the QuickScan® Mobile reader.

Enter configuration

3. Set Radio Address

+

four digits for the QuickScan® Mobile Address (from **0000** to **1999**).

All readers used in the same area must have different addresses.

4. Exit and Save configuration

5. Read the **Bind** code to pair the QuickScan® Mobile to the cradle. The reader is dedicated to the cradle. Any previously **bound** reader will be excluded.

Bind

The yellow LED on the QuickScan® Mobile will blink; the reader is ready to be positioned onto the cradle.

- Firmly position the reader onto the cradle within 10 seconds, a beep will be emitted, signaling that the cradle has been paired to the QuickScan[®] Mobile, and the yellow LED on the reader will go off.



- Read the cradle restore default code:

Restore cradle default



Go to par. 3.3 Interface Selection.

3.3 INTERFACE SELECTION

Read the interface selection code for your application.

RS-232

Standard



POS Terminals

Nixdorf Mode A



Fujitsu



ICL Mode



For POS terminal default settings refer to par. 4.9.

PEN



WEDGE (only for Quickscan M2 Type:130)

IBM AT or PS/2 PCs



IBM XT



PC Notebook



IBM SURE1



IBM Terminal 3153



WEDGE (CONTINUED)

IBM Terminals 31xx, 32xx, 34xx, 37xx:

To select the interface for these IBM Terminals, read the correct KEY TRANSMISSION code. Select the KEYBOARD TYPE if necessary (default = advanced keyboard).

KEY TRANSMISSION MODE

make-only keyboard



make-break keyboard



KEYBOARD TYPE

◆ advanced keyboard



typewriter keyboard



WEDGE (CONTINUED)

ALT MODE

The ALT-mode selection allows barcodes sent to the PC to be interpreted correctly independently from the Keyboard Nationality used. **You do not need to make a Keyboard Nationality selection.**

(default = Num Lock Unchanged). **Make sure the Num Lock key on your keyboard is ON.**

IBM AT - ALT mode



PC Notebook - ALT mode



WYSE TERMINALS

ANSI Keyboard



PC Keyboard



ASCII Keyboard



VT220 style Keyboard



WEDGE (CONTINUED)

DIGITAL TERMINALS

VT2xx/VT3xx/VT4xx



IBM 46XX (only for Quickscan M2 Type:110)

PORT 9B

4501 Protocol



(typical)

1520 Protocol



PORT 5B

1520 Protocol



(typical)

4501 Protocol



3.4 USB READER CONFIGURATION

The USB interface is compatible with:

Windows 98 (and later)

IBM POS for Windows

Mac OS 8.0 (and later)

4690 Operating System

USB Start-up

As with all USB devices, upon connection, the Host performs several checks by communicating with the QuickScan® Mobile. During this phase the yellow LED on the QuickScan® Mobile reader blinks and normal operations are suspended. Two basic conditions must be met before the QuickScan® Mobile is ready to read codes, the correct USB driver must be loaded and sufficient power must be supplied to the reader.

For all systems, the correct USB driver for the default USB-KBD interface is included in the Host Operating System and will either be loaded automatically or will be suggested by the O.S. and should therefore be selected from the dialog box (the first time only).

Normally the Host supplies sufficient power to the reader, the start-up phase ends correctly, the yellow LED stops blinking.

In rare cases, if the Host does not supply sufficient power to the reader, a dialog box will appear on the Host and the reader will be blocked (yellow LED continues blinking). In this case, disconnect the USB device cable at the Host (yellow LED stops blinking); and then try a different USB port as indicated by the Operating System message. You can now read codes.

At this point you can read the USB interface configuration code according to your application. Load drivers from the O.S. (if requested). When configuring the USB-COM interface, the relevant files and drivers must be installed from the USB Device Installation software, which can be downloaded from the web page <http://www.scanning.datalogic.com>.

The reader is ready to read barcodes. Successive start-ups will automatically recognize the previously loaded drivers.

First Start-Up

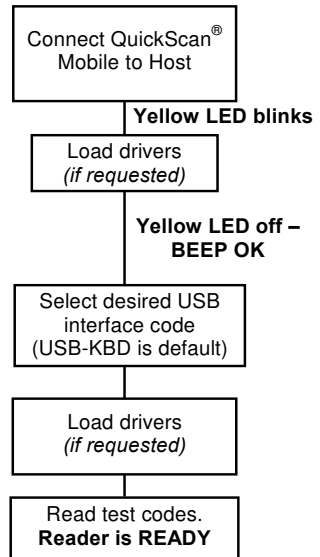

USB

USB-KBD



USB-KBD-ALT-MODE



USB-KBD-APPLE



USB-COM*



USB-IBM-Table Top



USB-IBM-Hand Held



* When configuring USB-COM, the relevant files and drivers must be installed from the USB Device Installation software, which can be downloaded from the web site <http://www.scanning.datalogic.com>.

3.5 CHANGING DEFAULT SETTINGS

Once your reader is setup, you can change the default parameters to meet your application needs. Refer to the preceding paragraphs for initial configuration in order to set the default values and select the interface for your application.

In this manual, the configuration parameters are divided into logical groups making it easy to find the desired function based on its reference group.

The first five groups are for Standard/IBM Interface parameter configuration:

RS-232

USB

WEDGE (only for Quickscan M2 type:130)

PEN EMULATION

IBM 46xx (only for Quickscan M2 type:110)

The following parameter groups are common to all interface applications:

DATA FORMAT parameters regard the messages sent to the Host system for all interfaces except Pen Emulation.

READING PARAMETERS control various operating modes and indicator status functioning.

DECODING PARAMETERS maintain correct barcode decoding in certain special reading conditions.

CODE SELECTION parameters allow configuration of a personalized mix of codes, code families and their options.

ADVANCED FORMATTING PARAMETERS allow code concatenation and advanced formatting of messages towards the Host. It cannot be used with Pen Emulation connections.

RADIO PARAMETERS (Mobile series only) allow configuration of radio control parameters.

RS-232 PARAMETERS

⊙	<i>BAUD RATE</i>	⊙
⊙	<i>PARITY</i>	⊙
⊙	<i>DATA BITS</i>	⊙
⊙	<i>STOP BITS</i>	⊙
⊙	<i>HANDSHAKING</i>	⊙
⊙	<i>ACK/NACK PROTOCOL</i>	⊙
⊙	<i>FIFO</i>	⊙
⊙	<i>INTER-CHARACTER DELAY</i>	⊙
⊙	<i>RX TIMEOUT</i>	⊙
⊙	<i>SERIAL TRIGGER LOCK</i>	⊙

1. Read the **Enter Configuration** code ONCE, available at the top of each page.
2. Read configuration codes from the desired groups.



= Read the code and follow the procedure given



= Default value

3. Read the **Exit and Save Configuration** code ONCE, available at the top of each page.



BAUD RATE

300 baud



600 baud



1200 baud



2400 baud



4800 baud



◆ 9600 baud



19200 baud



38400 baud





PARITY

◆ none



even parity



odd parity



DATA BITS

7 bits



◆ 8 bits



9 bits





STOP BITS

◆ 1 stop bit



2 stop bits



HANDSHAKING

◆ disable



hardware (RTS/CTS)



software (XON/XOFF)



RTS always ON



See par. 4.1.1 for details.



ACK/NACK PROTOCOL

◆ disable



enable



See par. 4.1.2 for details, particularly on implementing this parameter with QuickScan[®] Mobile.

FIFO

disable



◆ enable



See par. 4.1.3 for details.



INTER-CHARACTER DELAY

delay between characters transmitted to Host



Read 2 numbers from the table where:

00 = DELAY disabled

01-99 = DELAY from 1 to 99 milliseconds

◆ delay disabled

RX TIMEOUT

timeout control in reception from Host



Read 2 numbers from the table where:

00 = TIMEOUT disabled

01-99 = TIMEOUT from .1 to 9.9 seconds

◆ rx timeout 5 seconds

See par. 4.1.4 for details.



SERIAL TRIGGER LOCK

◆ disabled



enable and select characters



Read 2 characters from the Hex/Numeric table in the range 00-FE where:

- First Character enables device trigger
- Second Character inhibits device trigger until the first character is received again.

USB PARAMETERS



USB-COM

Handshaking, Ack/Nack protocol, FIFO, Inter-character delay, Rx timeout, Serial trigger lock



USB-KBD

Keyboard nationality, FIFO, Inter-character delay, Inter-code delay, Control character emulation, USB keyboard speed



USB-IBM

No parameter selection required.



- 1.** Read the **Enter Configuration** code ONCE, available at the top of each page.
- 2.** Read configuration codes from the desired groups.



= Read the code and follow the procedure given



= Default value

- 3.** Read the **Exit and Save Configuration** code ONCE, available at the top of each page.



HANDSHAKING

◆ disable



hardware (RTS/CTS)



software (XON/XOFF)



RTS always ON



See par. 4.1.1 for details.

ACK/NACK PROTOCOL

◆ disable



enable



See par. 4.1.2 for details.



FIFO

disable



◆ enable



See par. 4.1.3 for details.

INTER-CHARACTER DELAY

delay between characters transmitted to Host

**Read 2 numbers from the table where:**

00 = DELAY disabled

01-99 = DELAY from **1** to **99** milliseconds

◆ delay disabled



RX TIMEOUT



timeout control in reception from Host



Read 2 numbers from the table where:

00 = TIMEOUT disabled
01-99 = TIMEOUT from **.1** to **9.9** seconds

◆ rx timeout 5 seconds

See par. 4.1.4 for details.

SERIAL TRIGGER LOCK

◆ disabled



enable and select characters



Read 2 characters from the Hex/Numeric table in the range 00-FE where:

- First Character enables device trigger
- Second Character inhibits device trigger until the first character is received again.



USB-KBD

KEYBOARD NATIONALITY

Not Available for USB-KBD-ALT-MODE Interface

This parameter default value is restored through the Interface Selection code and not Restore Default.

Belgian



English



French



German



Italian



Japanese



Spanish



Swedish



◆ USA





FIFO

disable



◆ enable



See par. 4.1.3 for details.

INTER-CHARACTER DELAY

delay between characters transmitted to Host

**Read 2 numbers from the table where:**

00 = DELAY disabled

01-99 = DELAY from **1** to **99** milliseconds

◆ delay disabled



INTER-CODE DELAY



delay between codes transmitted to Host



Read 2 numbers from the table where:

- 00 = DELAY disabled
- 01-99 = DELAY from **1** to **99** seconds

◆ delay disabled

CONTROL CHARACTER EMULATION

◆ CTRL + Shift + Key



CTRL + Key





USB KEYBOARD SPEED

◆ Normal



Fast



WEDGE PARAMETERS

⊙	<i>KEYBOARD NATIONALITY</i>	⊙
⊙	<i>CAPS LOCK</i>	⊙
⊙	<i>CAPS LOCK AUTO-RECOGNITION</i>	⊙
⊙	<i>NUM LOCK</i>	⊙
⊙	<i>INTER-CHARACTER DELAY</i>	⊙
⊙	<i>INTER-CODE DELAY</i>	⊙
⊙	<i>KEYBOARD SETTING</i>	⊙
⊙	<i>CONTROL CHARACTER EMULATION</i>	⊙

1. Read the **Enter Configuration** code ONCE, available at the top of each page.

2. Read configuration codes from the desired groups.



= Read the code and follow the procedure given



= Default value

3. Read the **Exit and Save Configuration** code ONCE, available at the top of each page.



KEYBOARD NATIONALITY

Belgian



English



French



German



Italian



Spanish



Swedish



◆ USA



The Japanese Keyboard Nationality selection is valid only for IBM AT compatible PCs.

Japanese





CAPS LOCK

◆ caps lock OFF



caps lock ON



Select the appropriate code to match your keyboard caps lock status.

Note: Caps lock manual configuration is ignored when Caps Lock Auto-Recognition is enabled.

For **PC Notebook** interface selections, the caps lock status is automatically recognized; therefore this command is not necessary.

CAPS LOCK AUTO-RECOGNITION (IBM AT COMPATIBLE ONLY)

disable



◆ enable



**WEDGE**

NUM LOCK

toggle num lock



◆ num lock unchanged



This selection is used together with the Alt Mode interface selection for AT or Notebook PCs.

It changes the way the Alt Mode procedure is executed; therefore it should be set as follows:

- if your keyboard Num Lock is normally on use **num lock unchanged**
- if your keyboard Num Lock is normally off use **toggle num lock**

In this way the device will execute the Alt Mode procedure correctly for your application.

INTER-CHARACTER DELAY

delay between characters transmitted to Host

**Read 2 numbers from the table where:**

00 = DELAY disabled
 01-99 = DELAY from **1** to **99** milliseconds

◆ delay disabled



INTER-CODE DELAY



delay between codes transmitted to Host



Read 2 numbers from the table where:

- 00 = DELAY disabled
- 01-99 = DELAY from **1** to **99** seconds

◆ delay disabled



WEDGE

KEYBOARD SETTING

ALPHANUMERIC KEYBOARD SETTING

The reader can be used with terminals or PCs with various keyboard types and nationalities through a simple keyboard setting procedure.

The type of computer or terminal must be selected before activating the keyboard setting command.

Keyboard setting consists of communicating to the reader how to send data corresponding to the keyboard used in the application. The keys must be set in a specific order.

Press and release a key to set it.

Some characters may require more than one key pressed simultaneously during normal use (refer to the manual of your PC or terminal for keyboard use). The exact sequence must be indicated to the reader in this case pressing and releasing the different keys.

Example:

If one has to press the "Shift" and "4" keys simultaneously on the keyboard to transmit the character "\$" to the video, to set the "\$", press and release "Shift" then press and release "4".

Each pressed and released key must generate an acoustic signal on the reader, otherwise repress the key. Never press more than one key at the same time, even if this corresponds to the normal use of your keyboard.

Press "Backspace" to correct a wrong key entry. In this case the reader emits 2 beeps.

Note: "CAPS LOCK" and "NUM LOCK" must be off before starting the keyboard setting procedure. "SHIFT" must be repressed for each character and cannot be substituted by "CAPS LOCK".



setting the alphanumeric keyboard



Read the code above.

Press the keys shown in the following table according to their numerical order.

Some ASCII characters may be missing as this depends on the type of keyboard: these are generally particular characters relative to the various national symbologies. In this case:

- **The first 4 characters (Shift, Alt, Ctrl, and Backspace) can only be substituted with keys not used, or substituted with each other.**
- characters can be substituted with other single symbols (e.g. "SPACE") even if not included in the barcode set used.
- characters can be substituted with others corresponding to your keyboard.

The reader signals the end of the procedure with 2 beeps indicating the keys have been registered.

WEDGE

01 : Shift		
02 : Alt		
03 : Ctrl		
04 : Backspace		
05 : SPACE	28 : 7	51 : N
06 : !	29 : 8	52 : O
07 : "	30 : 9	53 : P
08 : #	31 : :	54 : Q
09 : \$	32 : ;	55 : R
10 : %	33 : <	56 : S
11 : &	34 : =	57 : T
12 : '	35 : >	58 : U
13 : (36 : ?	59 : V
14 :)	37 : @	60 : W
15 : *	38 : A	61 : X
16 : +	39 : B	62 : Y
17 : ,	40 : C	63 : Z
18 : -	41 : D	64 : [
19 : .	42 : E	65 : \
20 : /	43 : F	66 :]
21 : 0	44 : G	67 : ^
22 : 1	45 : H	68 : _ (underscore)
23 : 2	46 : I	69 : `
24 : 3	47 : J	70 : {
25 : 4	48 : K	71 :
26 : 5	49 : L	72 : }
27 : 6	50 : M	73 : ~
		74 : DEL

The keyboard setup functioning is signaled by the LEDs on the cradle. Each key stroke corresponds to a double blinking of the yellow LED.

By pressing the Backspace key the red LED on the cradle blinks, while the yellow LED stays on.



CAUTION

Do not place the reader onto the cradle during this procedure. Otherwise, the battery charging will occur modifying the LEDs functioning.

Once the procedure has been completed, the yellow LED turns off.



CONTROL CHARACTER EMULATION

◆ CTRL + Shift + Key



CTRL + Key



PEN EMULATION

⊙	<i>OPERATING MODE</i>	⊙
⊙	<i>MINIMUM OUTPUT PULSE</i>	⊙
⊙	<i>CONVERSION TO CODE 39</i>	⊙
⊙	<i>OVERFLOW</i>	⊙
⊙	<i>OUTPUT LEVEL</i>	⊙
⊙	<i>IDLE LEVEL</i>	⊙
⊙	<i>INTER-BLOCK DELAY</i>	⊙

1. Read the **Enter Configuration** code ONCE, available at the top of each page.

2. Read configuration codes from the desired groups.

◆ = Default value

3. Read the **Exit and Save Configuration** code ONCE, available at the top of each page.

PEN EMULATION

The operating mode parameters are complete commands and do not require reading the Enter and Exit configuration codes.

OPERATING MODE

◆ interpret mode



Interprets commands without sending them to the decoder.

transparent mode



Sends commands to the decoder without interpreting them.



MINIMUM OUTPUT PULSE

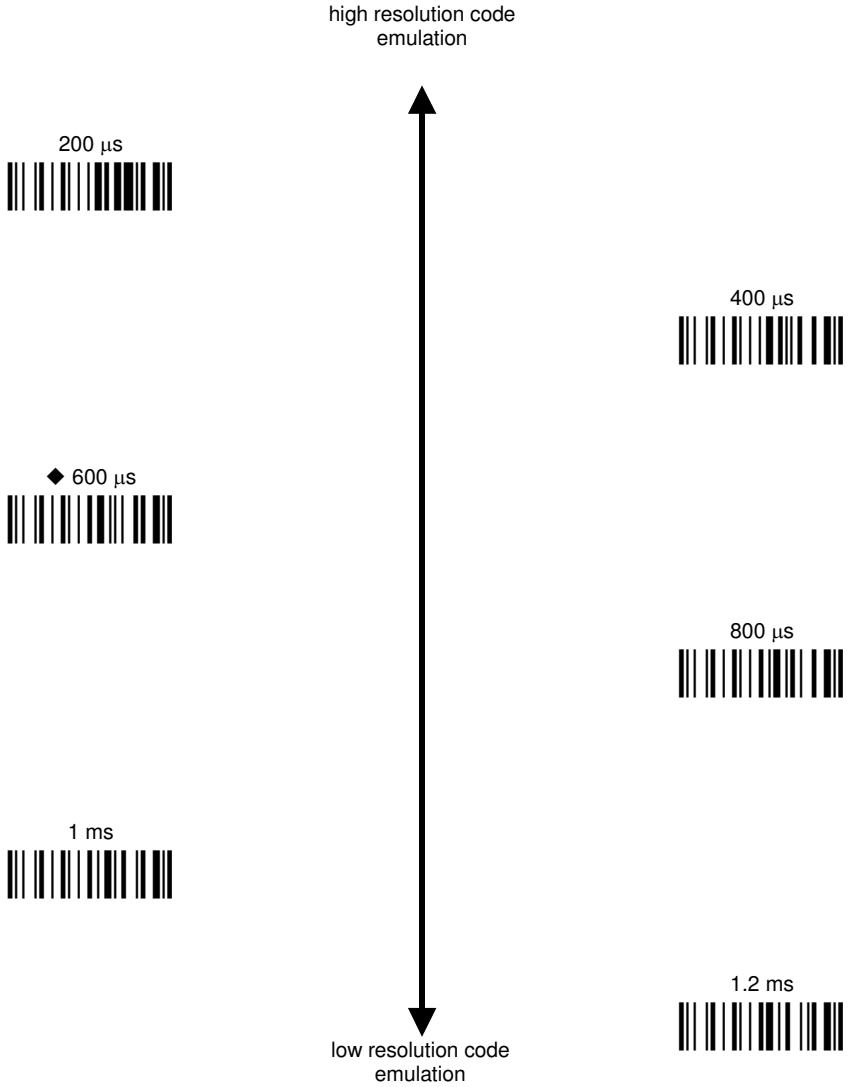

See par. 4.2.1 for details.



CONVERSION TO CODE 39 AND CODE 128

disable conversion to Code 39



Transmits codes in their original format.

enable conversion to Code 39



Converts codes read into Code 39 format.

enable conversion to Code 128



Converts codes read into Code 128 format.

See par. 4.2.2 for details.



OVERFLOW

narrow



◆ medium



wide



See par. 4.2.3 for details.

OUTPUT LEVEL

◆ normal
(white = logic level 0)



inverted
(white = logic level 1)



See par. 4.2.4 for details.



PEN EMULATION

IDLE LEVEL

◆ normal
(black level)



inverted
(white level)



See par. 4.2.4 for details.

INTER-BLOCK DELAY



delay between character blocks transmitted to Host



Read 2 numbers from the table where:

00 = DELAY disabled

01-99 = DELAY from .1 to **9.9** seconds

◆ delay disabled

See par. 4.2.5 for details.

IBM 46XX

⊙ *IBM DATA FORMATTING* ⊙

1. Read the **Enter Configuration** code ONCE, available at the top of each page.

2. Read configuration codes from the desired groups.

◆ = Default value

3. Read the **Exit and Save Configuration** code ONCE, available at the top of each page.



IBM DATA FORMATTING

conversion to Code 39



◆ IBM Standard



mixed IBM Standard + Code 39



◆ Cradle check the Host command



Cradle ignore Host command



See par. 4.3.1 for details.

DATA FORMAT

NOT FOR PEN INTERFACES

⊙	<i>CODE IDENTIFIER</i>	⊙
⊙	<i>CUSTOM CODE IDENTIFIER</i>	⊙
⊙	<i>HEADER</i>	⊙
⊙	<i>TERMINATOR</i>	⊙
⊙	<i>SPECIAL KEYS</i>	⊙
⊙	<i>FIELD ADJUSTMENT</i>	⊙
⊙	<i>FIELD ADJ. CHARACTER</i>	⊙
⊙	<i>CODE LENGTH TX</i>	⊙
⊙	<i>CHARACTER REPLACEMENT</i>	⊙
⊙	<i>ADDRESS STAMPING</i>	⊙
⊙	<i>ADDRESS DELIMITER</i>	⊙

1. Read the **Enter Configuration** code ONCE, available at the top of each page.

2. Read configuration codes from the desired groups.



= Read the code and follow the procedure given

◆ = Default value

3. Read the **Exit and Save Configuration** code ONCE, available at the top of each page.

DATA FORMAT

CODE IDENTIFIER TABLE			
CODE	AIM STANDARD	DATALOGIC STANDARD	Custom
2/5 interleaved] l y	N	
2/5 industrial] X y	P	
2/5 normal 5 bars] S y	O	
2/5 matrix 3 bars] X y	Q	
EAN 8] E 4	A	
EAN 13] E 0	B	
UPC A] X y	C	
UPC E] X y	D	
EAN 8 with 2 ADD ON] E 5	J	
EAN 8 with 5 ADD ON] E 6	K	
EAN 13 with 2 ADD ON] E 1	L	
EAN 13 with 5 ADD ON] E 2	M	
UPC A with 2 ADD ON] X y	F	
UPC A with 5 ADD ON] X y	G	
UPC E with 2 ADD ON] X y	H	
UPC E with 5 ADD ON] X y	I	
Code 39] A y	V	
Code 39 Full ASCII] A y	W	
CODABAR] F y	R	
ABC CODABAR] X y	S	
Code 128] C y	T	
EAN 128] C y	k	
ISBT 128] C4	f	
Code 93] G y	U	
CIP/39] X y	Y	
CIP/HR] X y	e	
Code 32] X y	X	
MSI] M y	Z	
Plessey Standard] P 0	a	
Plessey Anker] P 1	o	
Telepen] X 0	d	
Delta IBM] X 0	c	
Code 11] H y	b	
Code 16K] K 0	p	
Code 49] T y	q	
RSS Expanded Linear and Stacked] e 0	t	
RSS Limited] e 0	v	
RSS 14 Linear and Stacked] e 0	u	

DATA FORMAT

- AIM standard identifiers are not defined for all codes: the X identifier is assigned to the code for which the standard is not defined. The y value depends on the selected options (check digit tested or not, check digit tx or not, etc.).
- When customizing the Datalogic Standard code identifiers, 1 or 2 identifier characters can be defined for each code type. If only 1 identifier character is required, the second character must be selected as **FF** (disabled).
- The code identifier can be singly disabled for any code by simply selecting **FF** as the first identifier character.
- Write in the Custom character identifiers in the table above for your records.



DATA FORMAT



CODE IDENTIFIER

◆ disable



Datalogic standard



AIM standard



custom





CUSTOM CODE IDENTIFIER

define custom code identifier(s)



- ① Read the above code.
(Code Identifiers default to Datalogic standard, see table on previous page).
- ② Select the code type from the code table in Appendix B for the identifier you want to change.
- ③ You can define 1 or 2 identifier characters for each code type. If only 1 identifier character is required, the second character must be selected as **FF** (disabled). Read the hexadecimal value corresponding to the character(s) you want to define as identifiers for the code selected in step ②: valid characters are in the range **00-FD**. For Wedge and USB-KBD interfaces, it is also possible to read the **Special Key(s)** on page 58.

Example: To define Code 39 Code Identifier = @

Read define custom code identifier(s) + Code 39 + 40 + FF



HEADER

no header



one character header



two character header



three character header



four character header



five character header



six character header



seven character header



eight character header



After selecting **one** of the desired Header codes, read the character(s) from the HEX table. Valid characters are in the range **00-FE**. For Wedge and USB-KBD interfaces, it is also possible to read the **Special Key(s)** on page 58.

Example:

+ 41 + 42 + 43 + 44 = Header **ABCD**

For more details see par. 4.4.1.

***TERMINATOR***

no terminator



one character terminator

two character
terminator

three character terminator

four character
terminator

five character terminator



six character terminator



seven character terminator

eight character
terminator

After selecting **one** of the desired Header codes, read the character(s) from the HEX table. Valid characters are in the range **00-FE**. For Wedge and USB-KBD interfaces, it is also possible to read the **Special Key(s)** on page 58.

Example:

two character terminator



+ 0D + 0A = Terminator CR LF

For more details see par. 4.4.1.



SPECIAL KEYS

Available only for Wedge IBM AT-PS/2 and USB-KBD Interfaces



NOTE

It is necessary to define each Special Key by following the procedure given in par. 4.4.2.

Select one or more of the following Special Keys according to your needs.

Special Key 1



Special Key 2



Special Key 3



Special Key 4



Special Key 5



***FIELD ADJUSTMENT***

- ◆ disable field adjustment



Field adjustment allows a number of characters n , to be added to or subtracted from the barcode read. The adjustment can be different for each enabled code type. To define the field adjustment:

- ① Read the enable field adjustment code:

enable field adjustment



- ② Select the code type from the Code Identifier Table in Appendix B.
- ③ Select the type of adjustment to perform:

right addition



left addition



right deletion



left deletion



- ④ Read a number in the range
- 01 - 32**
- from the Hex/Numeric Table to define how many characters to add or delete:

Conditions:

- Adjustment is only performed on the barcode data; the Code Identifier and Code Length Transmission fields are not modified by the field adjustment parameter.
- If the field setting would subtract more characters than exist in the barcode, the subtraction will take place only to code length 0.
- You can set up to a maximum of 10 different field adjustments on the same barcode family or on different barcode families.

Example: To add 4 characters to the right of Standard Code 39 Codes:

Read  +  +  + **04**



FIELD ADJUSTMENT CHARACTER

- ① Read the field adjustment character code:



field adjustment character



- ② Read the hexadecimal value corresponding to the character you want to use for field adjustment. Valid characters are in the range **00-FE**. For Wedge and USB-KBD interfaces, it is also possible to read the **Special Key(s)** on page 58.

Example:

To define the field adjustment character = **A**:

field adjustment character
Read  + 41

CODE LENGTH TX

- ◆ code length not transmitted



code length transmitted in variable-digit format



code length transmitted in fixed 4-digit format



The code length is transmitted in the message after the Headers and Code Identifier characters. The code length is calculated after performing any field adjustment operations.



CHARACTER REPLACEMENT

◆ disable character replacement



This parameter allows up to three characters to be replaced from the barcode read. These substitutions are stored in memory. To define each character replacement:

- ① Read one of the following character replacement codes:

first character replacement



second character replacement



third character replacement



- ② From the Code Identifier Table in Appendix B, read the Code Identifier for the desired code family.
0 = character replacement will be effective for all code families.
- ③ From the Hex/Numeric Table read two characters corresponding to the Hex value (**00-FE**) which identifies the character to be replaced. For Wedge and USB-KBD interfaces, it is also possible to read the **Special Key(s)** on page 58.
- ④ From the Hex/Numeric Table read two characters corresponding to the Hex value (**00-FE**) which identifies the new character to replace. For Wedge and USB-KBD interfaces, it is also possible to read the **Special Key(s)** on page 58.
FF = the character to be replaced will be substituted with no character, that is, it will be removed from the code.

Example:

The following strings define:

1. *First Character Replacement:* substitution in *Code 39 barcodes* of all occurrences of the **0** character with the **1** character.
2. *Second Character Replacement:* substitution in *Code 39 barcodes* of all occurrences of the **A** character with the **B** character.

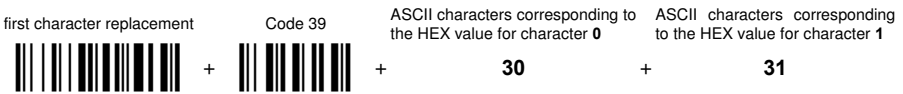

For Code 39 codes containing the string "**0123**", the contents transmitted will be "**1123**".

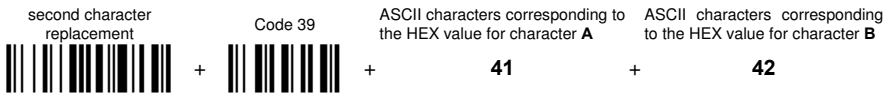

For Code 39 codes containing the string "**ABCD**", the contents transmitted will be "**BBCD**".



ADDRESS STAMPING

- ◆ disable reader address stamping



- enable reader address stamping



See par. 4.4.3 for details.

ADDRESS DELIMITER

- ◆ disable reader address delimiter



- enable reader address delimiter and select characters



Read 2 HEX characters in the range **00-FE**.

See par. 4.4.4 for details.

READING PARAMETERS

⊙	<i>HAND-HELD OPERATION</i>	⊙
⊙	<i>STAND OPERATION</i>	⊙
⊙	<i>HARDWARE TRIGGER MODE</i>	⊙
⊙	<i>TRIGGER-OFF TIMEOUT</i>	⊙
⊙	<i>FLASH MODE</i>	⊙
⊙	<i>READS PER CYCLE</i>	⊙
⊙	<i>SAFETY TIME</i>	⊙
⊙	<i>BEEPER INTENSITY</i>	⊙
⊙	<i>BEEPER TONE</i>	⊙
⊙	<i>BEEPER TYPE</i>	⊙
⊙	<i>BEEPER LENGTH</i>	⊙
⊙	<i>STAND RECOGNITION BEEP</i>	⊙

1. Read the **Enter Configuration** code ONCE, available at the top of each page.
2. Read configuration codes from the desired groups.



= Read the code and follow the procedure given



= Default value

3. Read the **Exit and Save Configuration** code ONCE, available at the top of each page.



READING PARAMETERS

HAND-HELD OPERATION

◆ hardware trigger



software trigger



* always on



* not available for Mobile series readers

automatic



hardware trigger ready



STAND OPERATION

ONLY Devices with Stand Recognition Beep

hardware trigger



software trigger



* always on



* not available for Mobile series readers

◆ automatic





READING PARAMETERS

HARDWARE TRIGGER MODE

◆ trigger active level



trigger active pulse



See par. 4.5.1 for details

TRIGGER-OFF TIMEOUT



trigger-off timeout



Read 2 numbers in the range 00-99:

00 = disables the trigger-off timeout

01-99 = corresponds to a max. 99-sec. delay after the trigger press to allow the reader to turn off automatically.

◆ trigger-off timeout disabled

See par. 4.5.2 for details.



READING PARAMETERS

FLASH MODE

"FLASH" ON duration



"FLASH" OFF duration



Read 2 numbers in the range 01-99:

01 to 99 = from .1 to 9.9 seconds.

◆ Flash-ON = 1 sec. Flash-OFF = 0.6 sec

READS PER CYCLE

◆ one read per cycle



multiple reads per cycle



See par. 4.5.3 for details.

***SAFETY TIME***

safety time

Limits same code consecutive reading.**Read 2 numbers in the range 00-99:**

00 = no same code consecutive reading until reader is removed (no decoding) for at least 400 ms.

01-99 = timeout from .1 to 9.9 seconds before a consecutive read on same code.

◆ safety time = 0.5 sec

See par. 4.5.4 for details.

BEEPER INTENSITY

* very low intensity



low intensity



medium intensity



◆ high intensity



- * This sets the beeper OFF for data entry, while for all other beeper signals it has the meaning "very low intensity". The Beeper Intensity parameter is effective for all operating conditions described in par. 5.2.



READING PARAMETERS

BEEPER TONE

tone 1



◆ tone 2



tone 3



tone 4



BEEPER TYPE

◆ monotone



bitonal



BEEPER LENGTH

long



◆ short





READING PARAMETERS



STAND RECOGNITION BEEP

ONLY Devices with Stand Recognition

disable



◆ enable



DECODING PARAMETERS

⊙	<i>INK SPREAD</i>	⊙
⊙	<i>OVERFLOW CONTROL</i>	⊙
⊙	<i>INTERDIGIT CONTROL</i>	⊙
⊙	<i>DECODING SAFETY</i>	⊙
⊙	<i>PUZZLE SOLVER™</i>	⊙



CAUTION

Before changing these parameter values read the descriptions in par. 4.6.

- 1.** Read the **Enter Configuration** code ONCE, available at the top of each page.
- 2.** Read configuration codes from the desired groups.
◆ = Default value
- 3.** Read the **Exit and Save Configuration** code ONCE, available at the top of each page.



INK SPREAD

disable



◆ enable



See par. 4.6.1 for details.

OVERFLOW CONTROL

disable



◆ enable



See par. 4.6.2 for details.



DECODING PARAMETERS

INTERDIGIT CONTROL

disable



◆ enable



See par. 4.6.3 for details.

DECODING SAFETY

◆ one read



(decoding safety disabled)

two reads



three reads



four reads



Required number of good reads before accepting code.



PUZZLE SOLVER™

◆ disable



enable



In the case of damaged or poorly printed codes, this parameter allows reading multiple parts of the single code to reconstruct it.

To read codes using this technology, simply move the illuminated bar over the code so that each line of the code is scanned. During this process a series of brief “ticks” indicates that reading is proceeding correctly.

Conditions:

- This parameter is only valid for the following codes:

EAN 8 without Add-on	EAN 13 without Add-on	UPC A without Add-on
Code 128	Code 39	

- For Code 39, Check digit control is forced.
- PuzzleSolver™ is not valid for ISBT 128 code.

CODE SELECTION

⊙	<i>EAN/UPC FAMILY</i>	⊙
⊙	<i>2/5 FAMILY</i>	⊙
⊙	<i>CODE 39 FAMILY</i>	⊙
⊙	<i>CODE 128 FAMILY</i>	⊙
⊙	<i>CODABAR FAMILY</i>	⊙
⊙	<i>CODE 93</i>	⊙
⊙	<i>MSI</i>	⊙
⊙	<i>PLESSEY</i>	⊙
⊙	<i>TELEPEN</i>	⊙
⊙	<i>DELTA IBM</i>	⊙
⊙	<i>CODE 11</i>	⊙
⊙	<i>CODE 16K</i>	⊙
⊙	<i>CODE 49</i>	⊙
⊙	<i>GS1 DATABAR™</i>	⊙

1. Read the **Enter Configuration** code ONCE, available at the top of each page.

2. Read configuration codes from the desired groups.



= Read the code and follow the procedure given



= Default value

3. Read the **Exit and Save Configuration** code ONCE, available at the top of each page.



CODE SELECTION

DISABLE ALL CODE FAMILIES



NOTE

The reader allows up to 5 code selections. This does not limit the number of CODES enabled to 5, as it depends on the code family.

**SINGLE
SELECTIONS =**

- ONE combination code from the EAN family
- ONE code from the 2/5 family

Example

5 code selections:

1. **2/5 Interleaved**
2. **2/5 Industrial**
3. Code 128 + EAN 128
4. Code 39 Full ASCII + Code 32
5. **UPC A/UPC E**

In this section all **SINGLE** code selections are **underlined and in bold.**

**CODE SELECTION**

EAN/UPC FAMILY

disable the family



- ① Read the desired family code

Note:

Since the EAN/UPC without ADD ON code selection is enabled by default, to correctly enable another selection, first disable the family.

WITHOUT ADD ON**◆ EAN 8/EAN 13/UPC A/UPC E****EAN 8/EAN 13****UPC A/UPC E**



CODE SELECTION

WITH ADD ON 2 AND 5

EAN 8/EAN 13/UPC A/UPC E



EAN 8/EAN 13



UPC A/UPC E



WITH ADD ON 2 ONLY

EAN 8/EAN 13



UPC A/UPC E



WITH ADD ON 5 ONLY

EAN 8/EAN 13



UPC A/UPC E



**CODE SELECTION**

WITH AND WITHOUT ADD ON**◆ EAN/UPC with and without ADD ON no
Autodiscrimination****EAN/UPC Autodiscrimination ADD ON by
Prefix**

By setting the EAN/UPC Autodiscrimination ADD ON by Prefix, the desired prefixes must be selected by reading the corresponding codes given in the following section, since no prefix is configured by default.

**CODE SELECTION****SELECT EAN/UPC PREFIXES****NOTE**

When scanning the following codes, barcodes starting with the selected prefixes will be read and transmitted only if the ADD ON is present. If no ADD ON is found, the barcode will not be read. Barcodes starting with different characters are read regardless of ADD ON presence and transmitted always without ADD ON.

◆ **Cancel All Selections**

OR

select one or more of the following prefixes:

378/379**434/439****414/419****977****978****979**

The commands above are not mutually exclusive. They can be used to configure more than one set of prefixes simultaneously.

**CODE SELECTION****Example:**

The following string allows reading and transmitting with ADD ON all EAN/UPC starting with the 434/439, 977 and 978 prefixes:

1. *EAN/UPC Autodiscrimination ADD ON by Prefix.*
2. *434/439:* enables reading and transmission with ADD ON of all EAN/UPC barcodes starting with 434/439 prefixes.
3. *977:* enables reading and transmission with ADD ON of all EAN/UPC barcodes starting with 977 prefix.
4. *978:* enables reading and transmission with ADD ON of all EAN/UPC barcodes starting with 978 prefix.

EAN/UPC Autodiscrimination ADD ON by
Prefix



To clear the current prefix selections:

1. *Cancel all Selections*





CODE SELECTION

EAN/UPC CHECK DIGIT TX SELECTIONS

For each code type in this family you can choose to transmit the check digit or not

CHECK DIGIT TRANSMISSION

◆ EAN 8



◆ EAN 13



◆ UPC A



◆ UPC E



NO CHECK DIGIT TRANSMISSION

EAN 8



EAN 13



UPC A



UPC E





CODE SELECTION

CONVERSION OPTIONS

UPC E to UPC A conversion



UPC E to EAN 13 conversion



UPC A to EAN 13 conversion



EAN 8 to EAN 13 conversion



Enable only ISBN conversion



Enable only ISSN conversion



Enable both ISBN and ISSN conversion



Disable both ISBN and ISSN conversion



**CODE SELECTION****2/5 FAMILY**

disable the family



① Read the desired family code

◆ **Interleaved 2/5****Normal 2/5 (5 Bars)****Industrial 2/5 (IATA)****Matrix 2/5 (3 Bars)**

② Read a check digit selection

CHECK DIGIT TABLE

no check digit control



◆ check digit control and transmission



check digit control without transmission

③ Read **4** numbers for the code length where:

- **First 2 digits** = minimum code length.
- **Second 2 digits** = maximum code length.

The maximum code length is **99** characters.

The minimum code length must always be less than or equal to the maximum.

Examples:

0199 = variable from 1 to 99 digits in the code.**1010** = 10 digit code length only.

The pharmaceutical code below is part of the 2/5 family but has no check digit or code length selections.

Code CIP/HR

French pharmaceutical code



CODE SELECTION

CODE 39 FAMILY

disables the family



① Read the desired family code

② Read a check digit selection

◆ **Standard Code 39**



◆ **no check digit control**



◆ **Full ASCII Code 39**



check digit control
and transmission



check digit control
without transmission





CODE SELECTION

The pharmaceutical codes below are part of the Code 39 family but have no check digit selections.

Code CIP39



French pharmaceutical code

Code 32



Italian pharmaceutical code

CODE LENGTH (optional)

The code length selection is valid for the entire Code 39 family

Read the code + 4 numbers for the code length where:

First 2 digits = minimum code length.

Second 2 digits = maximum code length.

set code length



The maximum code length is **99** characters.

The minimum code length must always be less than or equal to the maximum.

Examples: **0199** = variable from 1 to 99 digits in the code. **1010** = 10 digit code length only.



CODE SELECTION

CODE 128 FAMILY

disables the family



- ① Read the desired family code

◆ **Code 128**



control without transmission
of check digit

EAN 128



control without transmission
of check digit

Transmit GS Before Code

Code EAN 128 uses the ASCII <GS> character to separate a variable length code field from the next code field. This character can also be transmitted before the code.

◆ disable



enable



If the <GS> character has been modified in the Character Replacement parameter, the new character is affected by this command.



CODE SELECTION

ISBT 128



Enabling ISBT 128 automatically disables Puzzle Solver™.

CODE LENGTH (optional)

The code length selection is valid for the entire Code 128 family.

Read the code + 4 numbers for the code length where:

set code length

First 2 digits = minimum code length



Second 2 digits = maximum code length

The maximum code length is 99 characters. The minimum code length must always be less than or equal to the maximum.

Examples: **0199** = variable from 1 to 99 digits in the code. **1010** = 10 digit code length only.

The length is calculated on the output string.

CODE 93

◆ disables the code



Code 93



control without transmission
of check digit



CODE SELECTION

CODABAR FAMILY

◆ disable the family



① Read the desired equality control code

② Read a start/stop transmission selection

Standard Codabar



no start/stop character equality control

START/STOP CHARACTER TRANSMISSION

no transmission



Standard Codabar



start/stop character equality control

transmission



The Codabar ABC code below uses a fixed start/stop character transmission selection.

Codabar ABC



no start/stop character equality control but transmission.



CODE SELECTION

Codabar ABC Forced Concatenation

enable Codabar ABC with forced concatenation



non start/stop character equality control but transmission

CODE LENGTH (optional)

The code length selection is valid for the entire Codabar family

Read the code + 4 numbers for the code length where:

First 2 digits = minimum code length.

Second 2 digits = maximum code length.

set code length



The maximum code length is **99** characters.

The minimum code length must always be less than or equal to the maximum.

Examples: **0199** = variable from 1 to 99 digits in the code. **1010** = 10 digit code length only.

START/STOP CHARACTER CASE IN TRANSMISSION

The start/stop character case selections below are valid for the entire Codabar family:

transmit start/stop characters in lower case



transmit start/stop characters in upper case





CODE SELECTION

MSI

◆ disable the family



Enable the code by selecting one of the check digit selections.

no check digit control



MOD10 check digit control
no check digit transmission



MOD10 check digit control
check digit transmission



MOD11 - MOD10 check digit control
no check digit transmission



MOD11 - MOD10 check digit control
check digit transmission



MOD10 - MOD10 check digit control
no check digit transmission



MOD10 - MOD10 check digit control
check digit transmission





CODE SELECTION

PLESSEY

◆ disable the family



Enable the code by selecting one of the check digit selections.

Standard Plessey

no check digit control



check digit control
check digit transmitted



check digit control
check digit not transmitted



Anker Plessey

no check digit control



check digit control
check digit transmitted



check digit control
check digit not transmitted





CODE SELECTION

TELEPEN

◆ disable the family



Enable the code by selecting one of the check digit selections.

Numeric Telepen

no check digit control



check digit control
check digit transmitted



check digit control
check digit not transmitted



Alphanumeric Telepen

no check digit control



check digit control
check digit transmitted



check digit control
check digit not transmitted





CODE SELECTION



DELTA IBM

◆ disable the family



Enable the code by selecting one of the check digit selections.

no check digit control



Type 1 check digit control



Type 2 check digit control





CODE SELECTION

CODE 11

◆ disable the family



Enable the code by selecting one of the check digit selections.

no check digit control



Type C check digit control
check digit transmitted



Type C check digit control
check digit not transmitted



Type K check digit control
check digit transmitted



Type K check digit control
check digit not transmitted



Type C and Type K
check digit control
check digits transmitted



Type C and Type K
check digit control
check digits not transmitted





CODE SELECTION

CODE 16K

◆ disable the code



Code 16K



To read stacked codes, simply move the reader over the code so that each line of the code is scanned. During this process a series of brief “ticks” indicates that reading is proceeding correctly.

CODE 49

◆ disable the code



Code 49



To read stacked codes, simply move the reader over the code so that each line of the code is scanned. During this process a series of brief “ticks” indicates that reading is proceeding correctly.



CODE SELECTION

GS1 DATABAR™

◆ disable the family



DISABLE CODE

disable RSS Expanded Linear and Stacked



disable RSS Limited



disable RSS 14 Linear and Stacked



ENABLE CODE

enable RSS Expanded Linear and Stacked



enable RSS Limited



enable RSS 14 Linear and Stacked



To read stacked codes, simply move the reader over the code so that each line of the code is scanned. During this process a series of brief “ticks” indicates that reading is proceeding correctly.

ADVANCED FORMATTING

NOT FOR PEN INTERFACES

- ⊙ **CONCATENATION** ⊙
- ⊙ **ADVANCED FORMATTING** ⊙



NOTE

Please follow the setup procedure carefully for these parameters.



NOTE

The Advanced Formatting parameters may not be compatible with the IBM USB POS interface selection.

- 1.** Read the **Enter Configuration** code ONCE, available at the top of page .
- 2.** Read configuration codes **precisely following the numbered procedure given.**



= Read the code and follow the procedure given



= Default value

- 3.** Read the **Exit and Save Configuration** code ONCE, available at the top of page.



CONCATENATION

◆ disable



enable



Permits the concatenation of two codes defined by code type and length. It is possible to set a timeout for the second code reading and to define code transmission if the timeout expires.

The order of transmission is CODE 1-CODE 2.

Define Concatenation

1**Code 1**

code ID



Read the code type from the Code Identifier Table beginning in Appendix B.

code length



Read a number in the range **01-99** from the Hex/Numeric Table.

ADVANCED FORMATTING



2

Code 2

code ID



Read the code type from the [Code Identifier Table](#) beginning in Appendix B.

code length



Read a number in the range **01-99** from the Hex/Numeric Table.

3

Concatenation Result Code ID

use code 1 ID



use code 2 ID



Since you can concatenate codes from different families, you must select the Code ID character of the resulting code. The Code ID character will be sent in the output message only if it is enabled according to the Code Identifier selection (Datalogic, AIM, or Custom).

4

Concatenation Timeout

timeout



Read two numbers in the range **00 to 99**

00= no timeout

01-99 = timeout from 1 to 99 seconds

Define the timeout, which determines the valid waiting period between the two codes, in order to accept concatenation. If the timeout expires, the resulting action will be based on the following selection. (HHDII)

ADVANCED FORMATTING



5

Transmission after Timeout

no code transmitted
after timeout



only code 1 transmitted
(if read) after timeout



only code 2 transmitted
(if read) after timeout



either code 1 or code 2 transmitted
after timeout



ADVANCED FORMATTING

ADVANCED FORMATTING

Advanced formatting has been designed to offer you complete flexibility in changing the format of barcode data **before** transmitting it to the host system. This formatting will be performed when the barcode data meets certain criteria, which you will define in the following procedure.

Up to 4-advanced code management formats can be defined and saved in memory. For each format you must complete the entire configuration procedure:

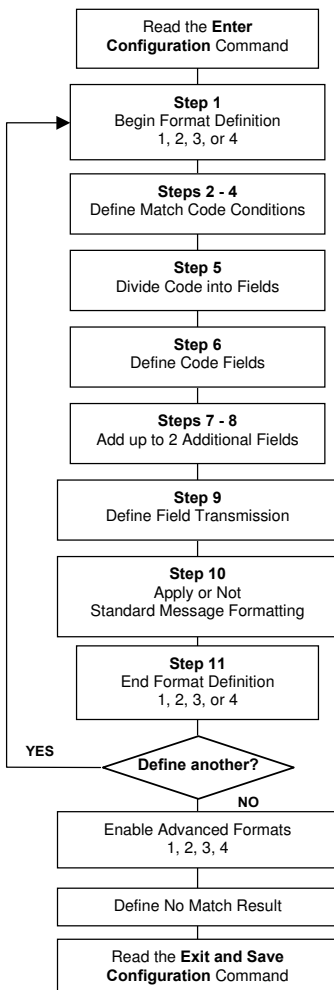



ADVANCED FORMATTING

1

Begin Format Definition

begin Format 1 definition



begin Format 2 definition



begin Format 3 definition



begin Format 4 definition



2

Match Code Type

match code type



Read the above code + the code type to match from the Code Identifier Table in Appendix B.

OR

any code type



3

Match Code Length

match code length



Read the above code + two numbers in the range **01** to **99** for the exact code length.

OR

any code length



ADVANCED FORMATTING



4

Match with Predefined Characters

no match



OR

match with 1 character



match with a 2-character string



match with a 3-character string



match with a 4-character string



After selecting the predefined match code, read the character(s) from the HEX table. Range of characters = **01-FE**.

Example:

Match code with the 2-character predefined string = "@@".

Read  + 40 + 40

AND

position of first character in predefined string



Read the above code + two numbers in the range **01** to **99** representing the character position in the code where the first character of the predefined string must be found.

Read **00** if the match string can be found in any character position.

ADVANCED FORMATTING



5

Divide Code into Fields



divide code into fields



Read one number in the range **1** to **5** to divide the code into fields.

6

Define Code Fields

define code fields

Each code field length can be set by either:

- a) defining a field separator character to be found in the code itself. In this case you can choose to **discard** the code separator character or **include** it as the last character of the field.

OR BY

- b) defining a match character to be found consecutively repeated in the code itself. In this case the field ends with the first character that does not match.

OR BY

- c) specifying a specific character length up to the maximum of 99 characters.

OR BY

- d) selecting the last field as variable length (if any).

You must define the same number of fields as selected in step 5, including fields that will not be transmitted.

ADVANCED FORMATTING



DEFINE FIELD 1 BY: EITHER

a)

field separator

Read the field separator character from the HEX table. Range of characters = **01-FE**.

discard separator



include separator



OR

b)

match character

Read the match character from the HEX table. Range of characters = **01-FE**.

OR

c)

field length

Read two numbers in the range **01** to **99** to define the field length.

OR

d)

this is the last field (variable length)



AND

Field 1 Terminators

no field terminators



1 field terminator



2 field terminators



Read the field terminator character(s) from the HEX table. Valid range of characters for all readers = **01-FE**. For Wedge and USB-KBD interfaces, it is also possible to read the **Special Key(s)** on page 58.

ADVANCED FORMATTING



DEFINE FIELD 2 BY: EITHER

a)

field separator

Read the field separator character from the HEX table. Range of characters = **01-FE**.

discard separator



include separator



OR

b)

match character

Read the match character from the HEX table. Range of characters = **01-FE**.

OR

c)

field length

Read two numbers in the range **01** to **99** to define the field length.

OR

d)

this is the last field (variable length)



AND

Field 2 Terminators

no field terminators



1 field terminator



2 field terminators



Read the field terminator character(s) from the HEX table. Valid range of characters for all readers = **01-FE**. For Wedge and USB-KBD interfaces, it is also possible to read the **Special Key(s)** on page 58.

ADVANCED FORMATTING



DEFINE FIELD 3 BY: EITHER

a) 

field separator

Read the field separator character from the HEX table. Range of characters = **01-FE**.

discard separator



include separator



OR

b) 

match character

Read the match character from the HEX table. Range of characters = **01-FE**.

OR

c) 

field length

Read two numbers in the range **01** to **99** to define the field length.

OR

d) 

this is the last field (variable length)



AND

Field 3 Terminators

no field terminators



1 field terminator



2 field terminators



Read the field terminator character(s) from the HEX table. Valid range of characters for all readers = **01-FE**. For Wedge and USB-KBD interfaces, it is also possible to read the **Special Key(s)** on page 58.

ADVANCED FORMATTING



DEFINE FIELD 4 BY: EITHER

a)

field separator

Read the field separator character from the HEX table. Range of characters = **01-FE**.

discard separator



include separator



OR

b)

match character

Read the match character from the HEX table. Range of characters = **01-FE**.

OR

c)

field length

Read two numbers in the range **01** to **99** to define the field length.

OR

d)

this is the last field (variable length)



AND

Field 4 Terminators

no field terminators



1 field terminator



2 field terminators



Read the field terminator character(s) from the HEX table. Valid range of characters for all readers = **01-FE**. For Wedge and USB-KBD interfaces, it is also possible to read the **Special Key(s)** on page 58.

ADVANCED FORMATTING



DEFINE FIELD 5 BY: EITHER

a)

field separator

Read the field separator character from the HEX table. Range of characters = **01-FE**.

discard separator



include separator



OR

b)

match character

Read the match character from the HEX table. Range of characters = **01-FE**.

OR

c)

field length

Read two numbers in the range **01** to **99** to define the field length.

OR

d)

this is the last field (variable length)



AND

Field 5 Terminators

no field terminators



1 field terminator



2 field terminators



Read the field terminator character(s) from the HEX table. Valid range of characters for all readers = **01-FE**. For Wedge and USB-KBD interfaces, it is also possible to read the **Special Key(s)** on page 58.

ADVANCED FORMATTING



7

First Additional Fixed Field

no fixed field



1 character fixed field



2 character fixed field



3 character fixed field



4 character fixed field



5 character fixed field



6 character fixed field



After selecting **one** of the Additional Fixed Field codes, read the corresponding character(s) from the HEX table. Range of characters = **01-FE**. For Wedge and USB-KBD interfaces, it is also possible to read the **Special Key(s)** on page 58.

Example:

4 Character Fixed Field

 $+ 4D + 41 + 49 + 4E = \text{MAIN}$

ADVANCED FORMATTING



8

Second Additional Fixed Field

no fixed field



1 character fixed field



2 character fixed field



3 character fixed field



4 character fixed field



5 character fixed field



6 character fixed field



After selecting **one** of the Additional Fixed Field codes, read the corresponding character(s) from the HEX table. Range of characters = **01-FE**. For Wedge and USB-KBD interfaces, it is also possible to read the **Special Key(s)** on page 58.

Example:

3 Character Fixed Field

 $+ 53 + 45 + 54 = \text{SET}$

ADVANCED FORMATTING



9

Field Transmission

number of fields to transmit



Read one number in the range **1** to **7** for the number of fields to transmit. **Include only fields to be transmitted.**

Field Order Transmission

Read the codes corresponding to the fields to transmit in the order in which they are to be transmitted. A field can be transmitted more than once. See example.

field 1



field 2



field 3



field 4



field 5



additional field 1



additional field 2



Example:

The barcode is divided into 3 defined fields plus 1 additional fixed field.
Transmit in the order: Field 2, Additional Field 1, Field 1, Field 2.

Number of Fields
to Transmit

+ 4 +

Field 2



+

Additional Field 1



+

Field 1



+

Field 2



ADVANCED FORMATTING



10**Standard Formatting**

do not apply standard formatting



apply standard formatting



After performing Advanced Formatting on the barcode read, Standard Formatting (Headers, Code Length, Code ID, Terminators) can be applied to the message to be transmitted.

11**End Format Definition**

end Format 1 definition



end Format 2 definition



end Format 3 definition



end Format 4 definition





ADVANCED FORMATTING

Enable Advanced Format

◆ no Advanced Formats enabled



enable



Advanced Format 1

disable



enable



Advanced Format 2

disable



enable



Advanced Format 3

disable



enable



Advanced Format 4

disable





ADVANCED FORMATTING



No Match Result

clear data - no transmission



transmit data using standard format



This selection determines the action to be taken when codes read do not conform to the advanced format requisites (no match).

- Codes not matching can be ignored, cleared from memory and not transmitted.
- Codes not matching can be transmitted using the Standard formatting (Headers, Code Length, Code ID, Terminators).

RADIO PARAMETERS

⊙	<i>RADIO PROTOCOL TIMEOUT</i>	⊙
⊙	<i>POWER-OFF TIMEOUT</i>	⊙
⊙	<i>BEEPER CONTROL FOR RADIO RESPONSE</i>	⊙
⊙	<i>SINGLE STORE</i>	⊙
⊙	<i>BATCH MODE</i>	⊙

1. Read the **Enter Configuration** code ONCE, available at the top of each page.

2. Read configuration codes from the desired groups.



= Read the code and follow the procedure given

3. Read the **Exit and Save Configuration** code ONCE, available at the top of each page.



RADIO PARAMETERS

RADIO PROTOCOL TIMEOUT

radio protocol timeout



Read a number from the table where:

02-19 = timeout from **2** to **19** seconds

◆ 2 seconds

See par. 4.7.1 for details.

POWER-OFF TIMEOUT

power-off timeout



Read 2 numbers in the range 00-99:

00 = Power-off disabled; reader always ready

01-99 = corresponds to a max. 99 hour delay before power-off.

◆ power-off after 4 hours.

See par. 4.7.2 for details.



RADIO PARAMETERS



BEEPER CONTROL FOR RADIO RESPONSE

◆ normal



only good decode



only good reception



off



See par. 4.7.3 for details.



RADIO PARAMETERS



SINGLE STORE

◆ disable



one attempt



two attempts



three attempts



four attempts



five attempts



six attempts



seven attempts



eight attempts



nine attempts



See par. 4.7.4 for details

**RADIO PARAMETERS**

BATCH MODE

◆ disable batch



enable normal batch



enable automatic batch



See par. 4.7.5 for details.

The following batch management parameters are complete commands and do not require reading the Enter and Exit configuration codes.

start normal batch transmission



delete batch data



4 REFERENCES

4.1 RS-232 PARAMETERS

4.1.1 Handshaking

Hardware handshaking: (RTS/CTS)

The RTS line is activated by the decoder before transmitting a character. Transmission is possible only if the CTS line (controlled by the Host) is active.

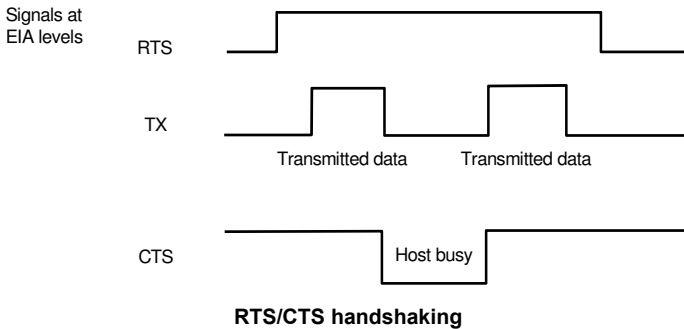

Software handshaking: (XON/XOFF)

During transmission, if the Host sends the XOFF character (13 Hex), the decoder interrupts the transmission with a maximum delay of one character and only resumes when the XON character (11 Hex) is received.

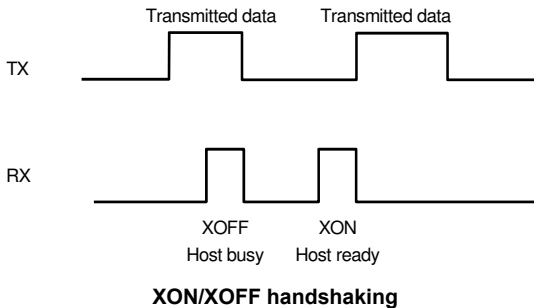

4.1.2 ACK/NACK Protocol

This parameter sets a transmission protocol in which the Host responds to the reader after every code transmitted. The Host sends an ACK character (06 HEX) in the case of good reception or the NACK character (15 HEX) requesting re-transmission, in the case of bad reception.

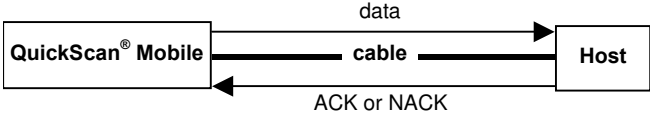

ACK/NACK enabled

If the reader does not receive an ACK or NACK, transmission is ended after the RX Timeout (see par. 4.1.4).

When ACK/NACK protocol is enabled, FIFO must be disabled manually, see par. 4.1.3.

The transmission protocol takes place between reader, cradle and Host. The reader passes its data (code read) to the cradle, which sends it to the Host.

In the following descriptions the completed transmission is indicated by the Beeper Control for Radio Response parameter with its default setting to Normal, see par. 4.7.3.

When ACK/NACK is disabled, there is no control from cradle to Host transmission, the reader responds with the good reception tone.

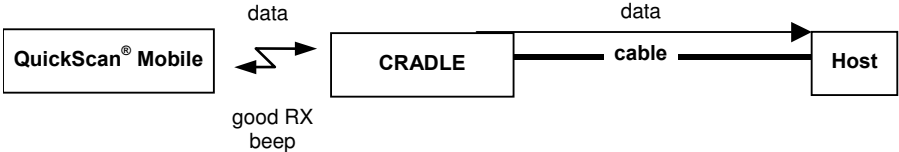

ACK/NACK disabled

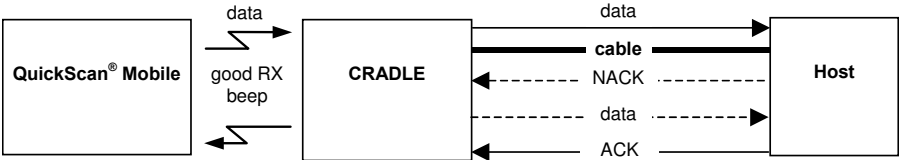

ACK/NACK enabled

When ACK/NACK is enabled, the Host sends an ACK character (06 HEX) in the case of good reception or the NACK character (15 HEX) requesting re-transmission, in the case of bad reception. Only after the ACK character is received by the cradle does the reader respond with the good reception tone.

If the reader does not receive an ACK or NACK, transmission is ended after the RX Timeout (see par. 4.1.4).

When ACK/NACK protocol is enabled, FIFO must be disabled manually, see par. 4.1.3.

4.1.3 FIFO

This parameter determines whether data (barcodes) are buffered on a First In First Out basis allowing faster data collection in certain cases for example when using slow baud rates and/or hardware handshaking.

If the FIFO buffering is enabled, codes are collected and sent out on the serial line in the order of acquisition. About 800 characters can be collected (buffer full), after which the reader signals an error and discards any further codes until the transmission is restored.

If the FIFO buffering is disabled, each code must be transmitted before another one can be read.

If enabled, the cradle collects all messages sent by QuickScan® Mobile and sends them in order of acquisition to the connected Host.

If disabled, QuickScan® Mobile blocks message transmission until the cradle has completed transmission towards the Host.

4.1.4 RX Timeout

When the RS-232 interface is selected, the Host can be used to configure the device by sending it command strings (see appendix A).

This parameter can be used to automatically end data reception from the Host after the specified period of time.

If no character is received from the Host, after the timeout expires, any incomplete string (any string not terminated by <CR>) is flushed from the device buffer.

4.2 PEN PARAMETERS

4.2.1 Minimum Output Pulse

This parameter sets the duration of the output pulse corresponding to the narrowest element in the barcode. In this way the code resolution is controlled by the signal sent to the decoder, independently of the physical resolution of the code read.

The shortest pulse (200 μ s) corresponds to a high resolution code emulation and therefore a shorter transfer speed to the decoder (for decoders able to work on high resolution codes). Likewise, longer pulses correspond to low resolution code emulation and therefore a longer transfer time to the decoder.

4.2.2 Conversion to Code 39 and Code 128

When using these readers it is possible to choose between converting the decoded codes into either Code 39 format or Code 128 format. It is not possible to disable conversion.

4.2.5 Inter-Block Delay

For the PEN Emulation interface, data are sent to the Host in fixed size blocks of 20 characters each. The inter-block delay parameter allows setting a delay between each block sent to the Host.

4.3 IBM 46XX

4.3.1 IBM Data Formatting (Transmission Format)

The IBM 46xx Series cash register recognizes the following codes:

- EAN 8 / EAN13 / UPC A / UPC E with and without Add On
- Interleaved 2/5
- **Code 39**
- Codabar
- Code 128
- Code 93
- Normal 2/5

The transmission format of codes belonging to this set is specified by the protocol. As the reader allows a wider set of codes to be selected, the following formats are defined to offer the user all the reading possibilities of the Datalogic product.

Conversion to Code 39 Format

Data from any code selected may be transmitted. Each code is transmitted to the Host as Code 39. Any character not included in the standard Code 39 set will be replaced with a "Space" (20 Hex).

IBM Standard Format

Only codes belonging to the above mentioned set may be transmitted. Each code transmitted to the Host is recognized by the identifier requested by the protocol. If the selected code does not belong to this set, it will not be transmitted.

Mixed IBM Standard + Code 39 Format

Data from any code selected may be transmitted. For codes belonging to the above mentioned set, the "IBM Standard Format" is applied. The "Code 39" Format applies to codes not belonging to this set.

Cradle Check the Host Command and Cradle Ignore the Host Command

By default the cradle accepts the configuration commands received by the Host. When the other command is selected, the cradle ignores completely the commands sent from the Host and maintains its configuration.

4.4 DATA FORMAT

The system always provides reader to host data communication using the following message formatting:

Output Message from QuickScan® Dx30 or QuickScan® Mobile Stand Alone Towards Host

**[Header] [Gun_Addr] [Gun_Addr_delimiter]] [Code ID] [Code Length] CODE
[Terminator]**

[Items in square brackets are optional.]

Output Message from QuickScan® Mobile STAR-System™ Towards Host

[Header] [Code ID] [Code Length] CODE [Terminator]

[Items in square brackets are optional.]

4.4.1 Header/Terminator Selection

The header/terminator selection is not effected by the reading of the restore default code. In fact, header and terminator default values depend on the interface selection:

RS-232: no header, terminator CR-LF

WEDGE: no header, terminator ENTER

These default values are always restored through the reading of RS-232 or WEDGE interface selection code, see chapter 2.

For the WEDGE interface, the following extended keyboard values can also be configured:

EXTENDED KEYBOARD TO HEX CONVERSION TABLE				
	IBM AT IBM 3153 APPLE ADB	IBM XT	IBM 31xx, 32xx, 34xx, 37xx	Wyse Digital
HEX	KEY	KEY	KEY	KEY
83	ENTER	ENTER	FIELD EXIT	RETURN
84	TAB	TAB	TAB	TAB
85	F1	F1	F1	F1
86	F2	F2	F2	F2
87	F3	F3	F3	F3
88	F4	F4	F4	F4
89	F5	F5	F5	F5
8A	F6	F6	F6	F6
8B	F7	F7	F7	F7
8C	F8	F8	F8	F8
8D	F9	F9	F9	F9
8E	F10	F10	F10	F10
8F	F11	ESC	F11	F11
90	F12	BACKSPACE	F12	F12
91	HOME	HOME	ENTER	F13
92	END	END	RESET	F14
93	PG UP	PG UP	INSERT	F15
94	PG DOWN	PG DOWN	DELETE	F16
95	↑	↑	FIELD -	UP
96	↓	↓	FIELD +	DOWN
97	←	←	ENTER (Paddle)	LEFT
98	→	→	PRINT	RIGHT
99	ESC	ESC		ESC
9A	CTRL (Right)	CTRL (Right)		CTRL (Right)
9B	Euro	Space	Space	Space

For all devices using IBM AT (compatible) Wedge or USB-KBD interfaces, all values from **9C** to **FE** send the relative simulated keypress when available or else the relative ALT-Mode sequence. See the Hex to Character Conversion Table in Appendix C.

For all devices using other Wedge interfaces, all values from **9C** to **FE** send the Space character.



4.4.2 Define Special Key Sequence

The Special Key(s) for **Wedge IBM AT-PS/2 and USB-KBD interface users** can be associated with a sequence of keyboard keys that otherwise could not be selected, i.e. ALT + F6, SHIFT + F1. These Special Keys can be used for:

- Headers/Terminators
- Character Replacement
- Field Adjustment
- Custom Code ID
- Advanced Formatting – Define Field
- Advanced Formatting – Additional Fixed Field

Follow the procedure to define the desired Special Key sequence:

1. Read the Enter Configuration code above and select the Special Key to define (one at a time):

Define Special Key 1



Define Special Key 2



Define Special Key 3



Define Special Key 4



Define Special Key 5





2. Read only one code to be associated with the special key sequence:

SHIFT



OR

CTRL



OR

ALT



OR

CTRL + SHIFT



OR

ALT + SHIFT



OR

CTRL + ALT



3. Select the character to be associated with the Special Key sequence by reading the codes corresponding to the 3 character values from Appendix C. Then, read the Exit and Save Configuration code above to complete the Special Key sequence.

The character values having the ^S and ^A symbols **require** SHIFT or ALT keys or key combinations in **step 2**, in particular:

^S = the character is obtained in combination with SHIFT

^A = the character is obtained in combination with ALT

The following character values change according to the keyboard nationality.

KEYB CHAR	ITA	USA	FR	BE	DE	UK	ES	SW	JP
!	016 ^S	016 ^S	04A	03E	016 ^S	016 ^S	016 ^S	016 ^S	016 ^S
"	01E ^S	052 ^S	026	026	01E ^S	01E ^S	01E ^S	01E ^S	01E ^S
#	052 ^A	026 ^S	026 ^A	026 ^A	05D	05D	026 ^A	026 ^S	026 ^S
\$	025 ^S	025 ^S	05B	05B	025 ^S	025 ^S	025 ^S	025 ^A	025 ^S
%	02E ^S	02E ^S	052 ^S	052 ^S	02E ^S	02E ^S	02E ^S	02E ^S	02E ^S
&	036 ^S	03D ^S	016	016	036 ^S	03D ^S	036 ^S	036 ^S	036 ^S
'	04E	052	025	025	05D ^S	052	04E	05D	03D ^S
(03E ^S	046 ^S	02E	02E	03E ^S	046 ^S	03E ^S	03E ^S	03E ^S
)	046 ^S	045 ^S	04E	04E	046 ^S	045 ^S	046 ^S	046 ^S	046 ^S
*	05B ^S	03E ^S	05D	05B ^S	05B	03E ^S	05B ^S	05D ^S	052 ^S
+	05B	055 ^S	055 ^S	04A ^S	05B	055 ^S	05B	04E	04C ^S
,	041	041	03A	03A	041	041	041	041	041
-	04A	04E	036	055	04A	04E	04A	04A	04E
.	049	049	041 ^S	041 ^S	049	049	049	049	049
/	03D ^S	04A	049 ^S	049 ^S	03D ^S	04A	03D ^S	03D ^S	04A
0	045	045	045 ^S	045 ^S	045	045	045	045	045
1	016	016	016 ^S	016 ^S	016	016	016	016	016
2	01E	01E	01E ^S	01E ^S	01E	01E	01E	01E	01E
3	026	026	026 ^S	026 ^S	026	026	026	026	026
4	025	025	025 ^S	025 ^S	025	025	025	025	025
5	02E	02E	02E ^S	02E ^S	02E	02E	02E	02E	02E
6	036	036	036 ^S	036 ^S	036	036	036	036	036
7	03D	03D	03D ^S	03D ^S	03D	03D	03D	03D	03D
8	03E	03E	03E ^S	03E ^S	03E	03E	03E	03E	03E
9	046	046	046 ^S	046 ^S	046	046	046	046	046

KEYB CHAR	ITA	USA	FR	BE	DE	UK	ES	SW	JP
:	049 ^S	04C ^S	049	049	049 ^S	04C ^S	049 ^S	049 ^S	052
;	041 ^S	04C	041	041	041 ^S	04C	041 ^S	041 ^S	04C
<	061	041 ^S	061	061	061	041 ^S	061	061	041 ^S
=	045 ^S	055	055	04A	045 ^S	055	045 ^S	045 ^S	04E ^S
>	061 ^S	049 ^S	061 ^S	061 ^S	061 ^S	049 ^S	061 ^S	061 ^S	049 ^S
?	04E	04A ^S	03A ^S	03A ^S	04E ^S	04A ^S	04E ^S	04E ^S	04A ^S
@	04C ^A	01E ^S	045 ^A	01E ^A	015 ^A	052 ^S	01E ^A	01E ^A	054
[054 ^A	054	02E ^A	054 ^A	052 ^S	054	054 ^A	03E ^A	05B
\	00E	05D	03E ^A	061 ^A	04C ^S	061	00E ^A	04E ^A	051
]	05B ^A	05B	04E ^A	05B ^A	054 ^S	05B	05B ^A	046 ^A	05D
^	055 ^S	036 ^S	046 ^A	054	00E	036 ^S	054 ^S	05B ^S	055
_	04A ^S	04E ^S	03E	055	04A ^S	04E ^S	04A ^S	04A ^S	051 ^S
' (accent)	-	00E	03D ^A	05D ^A	055 ^S	00E	054	055 ^S	054 ^S
a	01C	01C	015	015	01C	01C	01C	01C	01C
b	032	032	032	032	032	032	032	032	032
c	021	021	021	021	021	021	021	021	021
d	023	023	023	023	023	023	023	023	023
e	024	024	024	024	024	024	024	024	024
f	02B	02B	02B	02B	02B	02B	02B	02B	02B
g	034	034	034	034	034	034	034	034	034
h	033	033	033	033	033	033	033	033	033
i	043	043	043	043	043	043	043	043	043
j	03B	03B	03B	03B	03B	03B	03B	03B	03B
k	042	042	042	042	042	042	042	042	042
l	04B	04B	04B	04B	04B	04B	04B	04B	04B
m	03A	03A	04C	04C	03A	03A	03A	03A	03A
n	031	031	031	031	031	031	031	031	031
o	044	044	044	044	044	044	044	044	044
p	04D	04D	04D	04D	04D	04D	04D	04D	04D
q	015	015	01C	01C	015	015	015	015	015
r	02D	02D	02D	02D	02D	02D	02D	02D	02D
s	01B	01B	01B	01B	01B	01B	01B	01B	01B
t	02C	02C	02C	02C	02C	02C	02C	02C	02C
u	03C	03C	03C	03C	03C	03C	03C	03C	03C
v	02A	02A	02A	02A	02A	02A	02A	02A	02A

KEYB CHAR	ITA	USA	FR	BE	DE	UK	ES	SW	JP
w	01D	01D	01A	01A	01D	01D	01D	01D	01D
x	022	022	022	022	022	022	022	022	022
y	035	035	035	035	01A	035	035	035	035
z	01A	01A	01D	01D	035	01A	01A	01A	01A
{	-	054 ^S	025 ^A	046 ^A	052	054 ^S	052 ^A	03D ^A	05B ^S
	00E ^S	05D ^S	036 ^A	016 ^A	04C	061 ^S	016 ^A	061 ^A	06A ^S
}	-	05B ^S	055 ^A	045 ^A	054	05B ^S	05D ^A	045 ^A	05D ^S
~	-	00E ^S	01E ^A	04A ^A	04E	05D ^S	-	05B ^A	055 ^S



NOTE

To use upper case letters, it is necessary to read one of the SHIFT commands from step 2 before the value corresponding to the lower case letters.

The following key values are common to all the keyboard nationalities.

KEYB KEY	ITA	USA	FR	BE	DE	UK	ES	SW	JP
ENTER	05A	05A	05A	05A	05A	05A	05A	05A	05A
TAB	00D	00D	00D	00D	00D	00D	00D	00D	00D
F1	005	005	005	005	005	005	005	005	005
F2	006	006	006	006	006	006	006	006	006
F3	004	004	004	004	004	004	004	004	004
F4	00C	00C	00C	00C	00C	00C	00C	00C	00C
F5	003	003	003	003	003	003	003	003	003
F6	00B	00B	00B	00B	00B	00B	00B	00B	00B
F7	083	083	083	083	083	083	083	083	083
F8	00A	00A	00A	00A	00A	00A	00A	00A	00A
F9	001	001	001	001	001	001	001	001	001
F10	009	009	009	009	009	009	009	009	009
F11	078	078	078	078	078	078	078	078	078
F12	007	007	007	007	007	007	007	007	007
Home	26C	26C	26C	26C	26C	26C	26C	26C	26C
End	269	269	269	269	269	269	269	269	269
PG UP	27D	27D	27D	27D	27D	27D	27D	27D	27D
PG down	27A	27A	27A	27A	27A	27A	27A	27A	27A

KEYB CHAR	ITA	USA	FR	BE	DE	UK	ES	SW	JP
Up arrow	275	275	275	275	275	275	275	275	275
Down arrow	272	272	272	272	272	272	272	272	272
Left arrow	26B	26B	26B	26B	26B	26B	26B	26B	26B
Right arrow	274	274	274	274	274	274	274	274	274
Esc	076	076	076	076	076	076	076	076	076
Ctrl right	214	214	214	214	214	214	214	214	214
€	02E ^A	02E ^A	024 ^A	024 ^A	024 ^A	025 ^A	02E ^A	02E ^A	-
SPACE	029	029	029	029			029		029

**NOTE**

If Caps Lock Auto-Recognition is disabled, it is necessary to verify that the keyboard caps lock status matches the reader one.

EXAMPLES**- Defining Special Key Sequences -**

- the following example allows defining Special Key 1 as SHIFT + F5:



2. the following example allows defining Special Key 2 as CTRL + S (upper case):

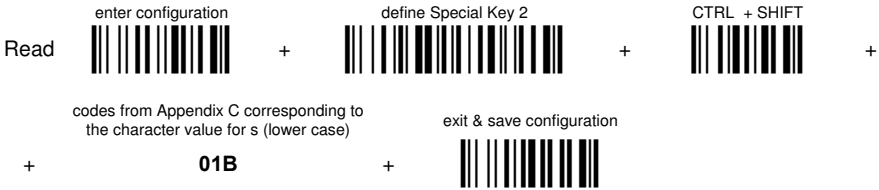

3. the following example allows defining Special Key 3 as Alt + F6:

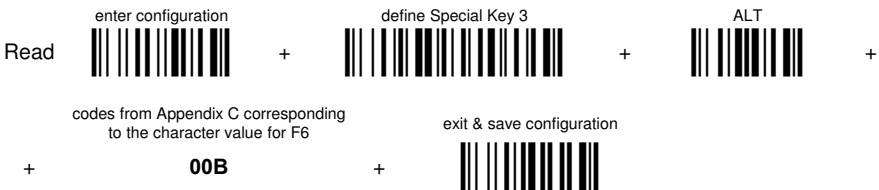

4. the following example allows defining Special Key 4 as Alt + Shift + F1:



- Integrating Special Keys in Headers/Terminators -

1. the following example allows setting Special Key 1 (defined in example 1 above) as terminator:



2. the following example allows setting Special Key 2 (defined in example 2 above) as header:



3. the following example allows setting Special Key 3 (defined in example 3 above) as header:



4. the following example allows setting Special Key 4 (defined in example 4 above) and ENTER character as terminators:

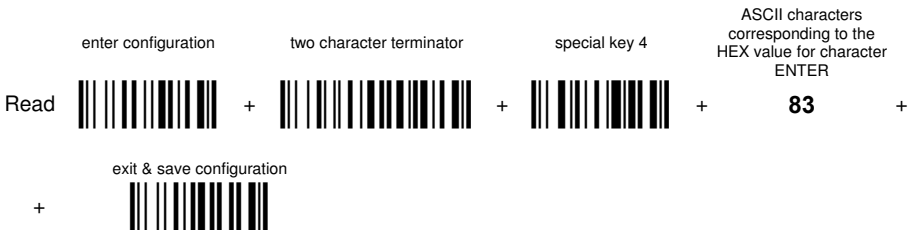

4.4.3 Address Stamping

It is possible to include the reader address in the message sent to the host. The reader Address Stamping parameter consists of a 4-digit number in the range 0000-1999.

For message output format, refer to par. 4.4.

4.4.4 Address Delimiter

The Address Delimiter allows a character to be included to separate the reader Address stamping field from the next field in the message. Any character can be included in the hexadecimal range from 00 to FE.

For message output format, refer to par. 4.4.

4.4.5 Enter Sleep Timeout

For readers that have the Sleep state enabled, this timeout determines when the reader will enter this state.

4.4.6 Standby

If this command is enabled, part of the CCD circuitry shuts down (Standby), in order to optimize low power consumption when not reading. When the trigger is pressed this circuitry powers up. This mode causes a minor delay of about 100 ms before the reader is ready.

Standby is always enabled and is not configurable. To exit Standby press the trigger.

4.5 READING PARAMETERS

4.5.1 Hardware Trigger Mode

This mode determines how the reading phase is controlled when the hardware trigger operating mode is selected:

- trigger active level: the reader goes ON when the trigger is pressed and goes OFF when it is released
- trigger active pulse: the reader goes ON at the first trigger press and goes OFF only at a second press

4.5.2 Trigger-Off Timeout

When this timeout is selected, the reader turns OFF automatically after the desired period of time.

4.5.3 Reads per Cycle

In general, a **reading cycle** corresponds to the ON + OFF times of a device. The resulting effects of this parameter on code reading depend on other related configuration conditions. Here are the definitions of ON and OFF times.

- For readers using the software trigger parameter (FLASH MODE), a reading cycle corresponds to the *flash on* + *flash off* times. Code reading takes place during the *flash on* time.

- For readers using the *hardware trigger* parameter, a reading cycle corresponds to a trigger press (ON) + one of the following OFF events:
 - trigger release (for *trigger active level*)
 - a second trigger press (for *trigger active pulse*)
 - trigger-off timeout* (see par. 4.5.2).

When **one read per cycle** is selected, the device decodes only one code during the ON period and immediately turns the reader OFF. It is only possible to read another code when the next ON time occurs.

In **multiple reads per cycle**, the ON period is extended so that the device can continue decoding codes until an OFF event occurs. For software trigger mode, the *flash on* period is immediately reset after each read and therefore extended. If another code is decoded before the reset *flash on* period expires, it is again reset and the effect is that the device remains ON, decoding codes until the *flash on* or *timeout* period expires.

The Safety Time parameter should be used in this case to avoid unwanted multiple reading of the same code, see par. 4.5.4.

4.5.4 Safety Time

Safety time prevents the device from immediately decoding the same code more than once. Same code consecutive reading can be disabled requiring the reader to be removed from the code (no decoding) for at least 400 ms, or a timeout can be set up to 9.9 seconds before the decoder will accept the same code. Reading is immediate if the code changes.

The safety time parameter is not applicable when reading stacked codes or when setting one read per cycle in hardware trigger operating mode, since these settings require voluntary action by the user.

4.6 DECODING PARAMETERS



CAUTION

These parameters are intended to enhance the decoding capability of the reader for particular applications. Used incorrectly, they can degrade the reading performance or increase the possibility of a decoding error.

4.6.1 Ink-Spread

The ink-spread parameter allows the decoding of codes, which are not perfectly printed because the page texture tends to absorb the ink.

4.6.2 Overflow Control

The overflow control parameter can be disabled when decoding codes printed on small surfaces, which do not allow the use of an overflow space.

This command does not affect code families 2/5, Code 128 and Code 93.

4.6.3 Interdigit Control

The interdigit control parameter verifies the interdigit spacing for code families Code 39 and Codabar.

4.7 RADIO PARAMETERS

4.7.1 Radio Protocol Timeout

This parameter sets the valid time to wait before transmission between the reader and the cradle is considered failed.

This parameter should be set taking into consideration the radio traffic (number of readers in the same area).

If the RS-232 interface is used with ACK/NACK enabled, this parameter should be at least equal to the RX Timeout parameter for low traffic environments. It should be increased if there are many readers in the same area.

It can be set between 2 and 19 seconds.

4.7.2 Power-Off Timeout

If this command is enabled, after the desired timeout in hours, the batteries are disconnected and all power consumption ceases. To restore power, press the trigger once. The reader will now be ready to read codes.

Power-off does not affect configuration parameters.

4.7.3 Beeper Control for Radio Response

The data entry good read tone normally results in two beeps; the first indicates that the reader has decoded the code; the second indicates whether cradle has received the data.

This can be changed according to the following selections:

- ◆ Normal: both good decode and good reception are signaled (two beeps).

- ◆ Only Good Decode: only the first beep indicating a good read is signaled.
- ◆ Only Good Reception: only the second beep indicating a good reception is signaled.
- ◆ Off: Neither good read nor good reception beeps are signaled.

For all configurations, any transmission errors will always be signaled.

4.7.4 Single Store

When single store mode is enabled, if the QuickScan[®] Mobile fails to transmit a code to the cradle, it enters a special operating mode that prevents the user from reading barcodes. When such operating mode is entered, the trigger no longer enables barcode reading but is used to retry transmission itself for the number of attempts selected in configuration. Once the transmission is successful the reader returns to the standard mode. If transmission is not successful after the number of configured attempts, the code is discarded.

Single store may be useful if you often read codes at the limit of the coverage area and there is a chance that code transmission can fail. In such case single store allows you to move to a more favorable position or location (i.e. closer to the cradle) and retry transmission without the necessity of re-reading the code since it is already stored in the reader.

Conversely, if single store is disabled, and the user wants to retry transmission, the code must be read again, and therefore the attempt must be made from basically the same location. If the user gives up, he does not know if the transaction was successful. (Actually the transmission could have been successful but the cradle may have been unable to acknowledge the message). There are applications in which there is no risk of transmission failure. In such cases it may be better to disable single store so that the user perceives a more consistent behavior of the trigger in that it always corresponds to code reading.

4.7.5 Batch Mode

This Operating Mode allows storing read codes in the internal reader RAM memory. The stored codes are transmitted to the base station at a later time according to the type of batch mode selected.

Batch mode can be enabled either manually (normal batch mode) or automatically.

Normal batch mode temporarily suspends radio communication between reader and base station allowing codes to be stored in the reader on a FIFO basis. This can be useful for example, if codes must be read from a location where there is no radio network. Upon returning to the system working area, this mode requires reading the **Start Normal Batch Transmission** barcode to successively transmit the list of







stored codes to the base station. The FIFO management assures that the first code read will be the first code to be transmitted to the base station.

The **Delete Batch Data** barcode allows canceling all barcode data stored in the reader.

Automatic batch mode allows codes to be stored in the reader on a FIFO basis whenever the reader is out of radio range. In this case radio communication is not suspended and transmission is attempted after each code read. If transmission cannot be successfully completed, then the code is added to the list. When the reader returns in range, transmission of the codes to the base station resumes automatically, according to the selected communication protocol, upon simply pressing and releasing the trigger or by successfully reading a new code.

4.8 CONFIGURATION EDITING COMMANDS

The following commands carry out their specific function and then exit the configuration environment.

Command	Description
	Restore the reader default configuration (see the relative Quick Reference Manual for default settings)
	Transmit the reader Software release
	Transmit the reader configuration in ASCII format. This command is not effective with Pen emulation interface or with the reader model.
	Restore the cradle default configuration (see the relative Quick Reference Manual for default settings)
	Transmit the cradle Software release.
	Transmit the cradle configuration in ASCII format. This command is not effective with Pen emulation interface.

4.9 DEFAULT PARAMETERS FOR POS TERMINALS

The default values of the RS-232 and Data Format parameters for POS terminals are listed in the following table:

	NIXDORF Mode A	FUJITSU	ICL Mode
RS-232 Group			
Baud Rate	9600	9600	9600
Parity	Odd	None	Even
Data Bits	8	8	8
Stop Bits	1	1	1
Handshaking	Hardware (RTS/CTS)	None	RTS always ON
ACK/NACK Protocol	Disabled	Disabled	Disabled
FIFO	Disabled	Enabled	Enabled
Inter-Character Delay	Disabled	Disabled	Disabled
RX Timeout	9.9 sec	2 sec	9.9 sec
Serial Trigger Lock	Disabled	Disabled	Disabled
Data Format Group			
Code Identifier	Custom	Custom	Custom
Header	No Header	No Header	No Header
Terminator	CR	CR	CR
Field Adjustment	Disabled	Disabled	Disabled
Code Length TX	Not Transmitted	Not Transmitted	Not Transmitted
Character Replacement	Disabled	Disabled	Disabled
Address Stamping	Disabled	Disabled	Disabled
Address Delimiter	Disabled	Disabled	Disabled

The table below lists all the Code Identifiers available for the POS terminals:

CODE	NIXDORF Mode A	FUJITSU	ICL Mode
UPC-A	A0	A	A
UPC-E	C0	E	E
EAN-8	B	FF	FF
EAN-13	A	F	F
Code 39	M	None	C [code length]
Codabar	N	None	N [code length]
Code 128	K	None	L [code length]
Interleaved 2 of 5	I	None	I [code length]
Code 93	L	None	None
Industrial 2 of 5	H	None	H [code length]
UCC/EAN 128	P	None	L [code length]
MSI/Plessey	O	None	None
RSS	E	None	None
Other	None	None	None

5 TECHNICAL FEATURES

QuickScan® Mobile Reader and Cradle

Electrical Features - READER	
Battery Type	1 Lithium battery 700 mAh
Time of recharge Lithium	max 6 hours with USB cable
Operating autonomy	typical 20000 reads
Indicators	LED, Beeper
Max scan rate	235 scans/sec
Electrical Features - CRADLE	
Supply voltage	5 VDC ± 5%
Power consumption	max. 4 W (charging)
LED Indicators	Battery charging red Charge completed green Power / Data yellow
Optical Features	
Sensor	CCD solid state (2088 pixels)
Illuminator	LED array
Wavelength	630 ~ 670 nm
Max. LED Output Power	0.33 mW
LED safety class	Class 1 EN 60825-1
Reading field	see reading diagram
Max. resolution	0.10 mm, 4 mils
PCS minimum	20% (Datalogic Test Chart)
Environmental Features – READER	
Working Temperature	0°to + 40 °C (32° to 104 °F)
Storage Temperature (without battery)	-20° to 70 °C (-4° to 158 °F)
Humidity	90% non condensing
Drop resistance	IEC 68-2-32 Test ED 1.5 m (4 ft 9 in)
Protection class	IP30
Environmental Features - CRADLE	
Working temperature	0° to 40 °C (32° to 104 °F)
Storage temperature	-20° to 70 °C (-4° to 158 °F)
Humidity	90 % non condensing
Protection class	IP30

Mechanical Features – READER	
Weight (without batteries)	about 189 g (6.66 oz)
Dimensions	171 x 90 x 68 mm (6.72 x 3.54 x 2.80 in)
Material	Cycoloy C 2800 with desmopan 3855
Mechanical Features – CRADLE	
Weight	181 gr (6.38 oz)
Dimensions	80 x 130 x 90 mm (3.15 x 5.11 x 3.54 in)
Material	Cycoloy C 2800 with desmopan 3855

QuickScan® Mobile Radio Features

Radio Features	European Models	USA Models
Radio Frequency	433.92 MHz	910 MHz
Bit rate	19200 baud	36800 baud
Effective Radiated Power	<10 mW	<1 mW
Range (in open air)	12 m	12 m
RF Modulation	FSK	

5.1 SYSTEM AND RADIO FEATURES

Radio Features		
Radio Frequency	433.92 MHz	
Bit Rate	19200	
Range (in open air)	30 m	
RF Modulation	FSK	
System Configurations	CRADLE	STARGATE™
Maximum number of devices per base stations	16	255
Maximum number of devices in the same reading area	2000	
Maximum number of base stations in network	-	16

5.2 STATUS INDICATORS

The reader has a LED indicator and a Beeper. The cradle has three LEDs. They signal several operating conditions, which are described in the tables below.

H = high tone

L = low tone

READER START-UP

Beeper¹	Meaning
L L L L	Parameters loaded correctly
H H H H long tones	Parameter loading error, reading or writing error in the non volatile memory
H L H L	Hardware error in EEPROM

READER CONFIGURATION

Beeper¹	Meaning
H H H H	Correct entry or exit from Configuration mode
L	Good read of a command
L L L	Command read error

READER DATA ENTRY

Beeper¹	LED	Meaning
one beep ²	ON	Correct read of a code in normal mode
H L long		TX buffer full (when FIFO is enabled) or TX error between QuickScan® Mobile and the cradle
H long	ON	Successful advanced format concatenation
H H H		Timeout expired – operation not completed
H H long		Error in advanced data formatting
	OFF	Ready to read a code

READER POWER

Beeper	LED	Meaning
10 short H	10 short blinks	Low Battery

READER BIND AND JOIN

Beeper¹	LED	Meaning
	Blinking	Command accepted; reader ready to be inserted into the cradle
L		Success
H L long tones		Failure

¹ Only the Beeper Intensity command can modify these signals.

² The data entry good read tone is user-configurable with all the Beeper commands in the Reading Parameters section.

Normally this results in two beeps; the first indicates that the reader has decoded the code, the second indicates whether the cradle has received the data. See also par. 4.7.3.

CRADLE CHARGE STATUS, POWER/COMMUNICATION

Red LED	Green LED	Yellow LED	BEEPER	Meaning
ON				Charging
	ON			End of charge
Blinking	Blinking		Repetitive beep	Charging out of temperature range, over-current or over-voltage conditions
		ON		Power applied
		Blinking		Receiving data and commands from the Host or the reader

5.3 READING DIAGRAMS

QUICKSCAN® MOBILE

Reading diagram at 25 °C and 300 lux ambient lighting
 Reading Zones (10° skew angle)

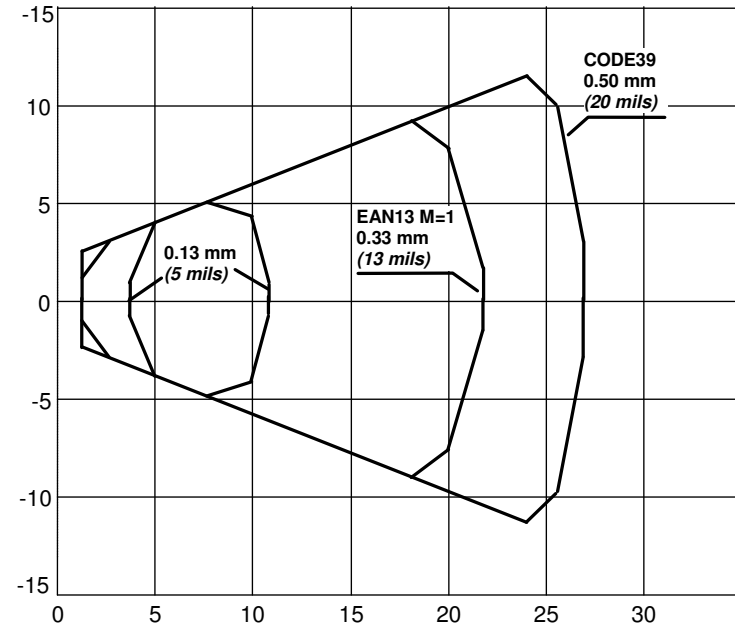

A HOST CONFIGURATION STRINGS

In this section we provide a description of how to modify the device configuration using serial strings sent from the Host.

This method requires either the RS-232 or USB-COM interface.

The device configuration can be changed by receiving commands from the Host through the serial interface. When this method is used, the programming sequence format is the following:

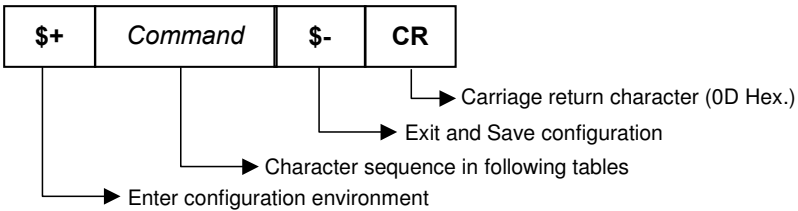

Example:

Multiple command programming sequence:

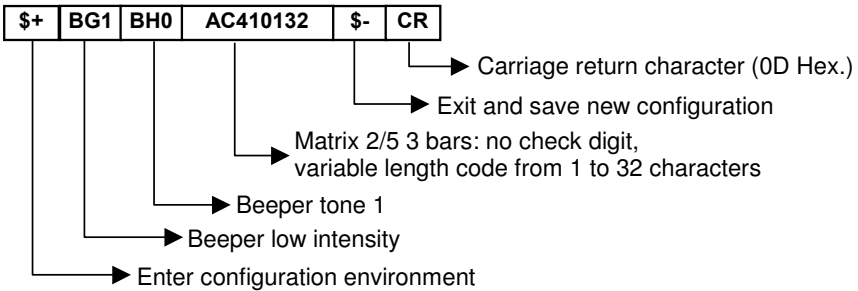

Each configuration parameter setting removes the condition previously active for that parameter.



NOTE

The device buffer can contain about 400 characters. If your programming string goes over this value, you must split it into separate groups and send each group after a delay of at least 3 seconds to give the reader time to empty the buffer and interpret the commands.

SERIAL CONFIGURATION STRINGS

ENTER/EXIT CONFIGURATION COMMANDS	
DESCRIPTION	STRING
Enter Configuration	\$+
Exit and Save Configuration	\$-
Restore Default	\$*
Transmit Software Release (not for PEN emulation)	#!
Transmit Device Configuration in ASCII (not for PEN emulation)	\$\$

These commands do not require \$-.

INTERFACE SELECTION			
DESCRIPTION	STRING		
RS-232	Standard	CP0	
	ICL Mode	CM0	
	Fujitsu	CM1	
	Nixdorf Mode A	CM2ECO	
WEDGE	for IBM AT	CP500	
	for IBM Terminals: 31xx, 32xx, 34xx, 37xx; make-break keyboard	CP501	
	for IBM Terminals: 31xx, 32xx, 34xx, 37xx; make-only keyboard	CP502	
	Keyboard Type for IBM Terminals 31xx, 32xx, 34xx, 37xx	typewriter	FK0
		advanced	FK1
	for IBM XT	CP503	
	for IBM Terminal 3153	CP504	
	for IBM PC Notebook	CP505	
	for IBM SURE1	CP506	
	for IBM AT - ALT mode	CP507	
	for IBM PC Notebook - ALT mode	CP508	
	for Wyse Terminal - ANSI Keyboard	CP509	
	for Wyse Terminal - PC Keyboard	CP510	
	for Wyse Terminal - ASCII Keyboard	CP511	
for Wyse Terminal - VT220 style Keyboard	CP514		
for Digital Terminals VT2xx/3xx/4xx	CP512		
for Apple ADB Bus	CP513		
PEN EMULATION	CP6		
USB	USB-KBD	UA03	
	USB-KBD-ALT-MODE	UA04	
	USB-KBD-APPLE	UA05	
	USB-COM	UA02	
	USB-IBM-Table Top	UA00	
	USB-IBM-Hand Held	UA01	

RS-232		
DESCRIPTION		STRING
Baud rate	300	CD1
	600	CD2
	1200	CD3
	2400	CD4
	4800	CD5
	9600	CD6
	19200	CD7
	38400	CD8
Parity	none	CC0
	even	CC1
	odd	CC2
Data bits	7	CA0
	8	CA1
	9	CA2
Stop bits	1	CB0
	2	CB1
Handshaking	disable	CE0
	RTS/CTS	CE1
	XON/XOFF	CE2
	RTS always On	CE3
ACK/NACK Protocol	disable	ER0
	enable	ER1
FIFO	disable	EC0
	enable	EC1
Inter-character delay (<i>ms</i>)		CK00 - CK99
RX Timeout (<i>100 ms</i>)		CL00 - CL99
Serial Trigger Lock	disable	CR0
	enable and select characters	CR1<i>ab</i>

a = Hex values representing an ASCII character from **00** to **FE** enabling the device trigger.

b = HEX values representing an ASCII character from **00** to **FE** inhibiting the device trigger.

USB		
DESCRIPTION		STRING
USB-COM		
Handshaking	disable	CE0
	RTS/CTS	CE1
	XON/XOFF	CE2
	RTS always ON	CE3
ACK/NACK Protocol	disable	ER0
	enable	ER1
FIFO	disable	EC0
	enable	EC1
Inter-character delay (<i>ms</i>)		CK00 - CK99
RX Timeout (<i>100 ms</i>)		CL00 - CL99
Serial Trigger Lock	disable	CR0
	enable	CR1 <i>ab</i>
USB-KBD		
Keyboard nationality (not for USB-KBD-ALT-MODE)	Belgian	FJ7
	English	FJ4
	French	FJ2
	German	FJ3
	Italian	FJ1
	Japanese	FJ8
	Spanish	FJ6
	Swedish	FJ5
	USA	FJ0
FIFO	disable	EC0
	enable	EC1
Delays	Inter-Character (<i>ms</i>)	CK00 - CK99
	Inter-Code (<i>s</i>)	FG00 - FG99
Control Character Emulation	CTRL + Shift + Key	FO0
	CTRL + Key	FO1
USB Keyboard Speed	Normal	UT10
	Fast	UT01

a = Hex values representing an ASCII character from **00** to **FE** enabling the device trigger.

b = HEX values representing an ASCII character from **00** to **FE** inhibiting the device trigger.

WEDGE		
DESCRIPTION		STRING
Keyboard nationality	Belgian	FJ7
	English	FJ4
	French	FJ2
	German	FJ3
	Italian	FJ1
	Spanish	FJ6
	Swedish	FJ5
	USA	FJ0
Caps Lock	caps Lock ON	FE1
	caps Lock OFF	FE0
Caps Lock Auto-Recognition (IBM AT compatible only)	disable	FP0
	enable	FP1
Num Lock	Toggle Num Lock	FL1
	Num Lock Unchanged	FL0
Delays	Inter-Character (<i>ms</i>)	CK00 - CK99
	Inter-Code (<i>s</i>)	FG00 - FG99
Control Character Emulation	CTRL + Shift + Key	FO0
	CTRL + Key	FO1

PEN		
DESCRIPTION		STRING
Operating mode	interpret (does not require \$+ or \$-)	\$]
	transparent (does not require \$+ or \$-)	\${
Minimum output pulse	200µs	DG0
	400µs	DG1
	600µs	DG2
	800µs	DG3
	1 ms	DG4
	1.2 ms	DG5
Conversion to Code 39 and Code 128	enable conversion to Code 39	DA1
	enable conversion to Code 128 (M series only)	DA2
Output level	normal	DD0
	inverted	DD1
Idle level	normal	DE0
	inverted	DE1
Overflow	narrow overflow	DH0
	medium overflow	DH1
	wide overflow	DH2
Inter-Block delay (100 ms)		CK00-CK99

DATA FORMAT		
<i>NOT FOR PEN EMULATION INTERFACES</i>		
DESCRIPTION		STRING
Code Identifier	disable	EB0
	Datalogic standard	EB1
	AIM standard	EB2
	Custom	EB3
Custom Code Identifier		EH<i>abc</i>
Headers	no header	EA00
	one character	EA01<i>x</i>
	two characters	EA02<i>xx</i>
	three characters	EA03<i>xxx</i>
	four characters	EA04<i>xxxx</i>
	five characters	EA05<i>xxxxx</i>
	six characters	EA06<i>xxxxxx</i>
	seven characters	EA07<i>xxxxxxx</i>
eight characters	EA08<i>xxxxxxxx</i>	
Terminators	no terminator	EA10
	one character	EA11<i>x</i>
	two characters	EA12<i>xx</i>
	three characters	EA13<i>xxx</i>
	four characters	EA14<i>xxxx</i>
	five characters	EA15<i>xxxxx</i>
	six characters	EA16<i>xxxxxx</i>
	seven characters	EA17<i>xxxxxxx</i>
eight characters	EA18<i>xxxxxxxx</i>	
Special Keys	special key 1	9C
	special key 2	9D
	special key 3	9E
	special key 4	9F
	special key 5	A0

a = ASCII character.

b, c, x = HEX values representing an ASCII character.

a = ASCII character of the DATALOGIC STANDARD Code Identifier from the table on page 52.

b = Hex value of the first Custom Code Identifier character from **00** to **FD**;
FF = disable Code Identifier

c = Hex value of the second Custom Code Identifier character from **00** to **FD**;
FF = disable second character of Custom Code Identifier

x = Hex value from **00** to **FE**

DATA FORMAT (continued)		
NOT FOR PEN EMULATION INTERFACES		
DESCRIPTION		STRING
Code Length Tx	not transmitted	EE0
	transmitted in variable-digit format	EE1
	transmitted in fixed 4-digit format	EE2
Field Adjustment	disable	EF0
	right addition	EFa0d
	left addition	EFa1d
	right deletion	EFa2d
	left deletion	EFa3d
Field Adjustment Character		EGe
Character Replacement	disable character replacement	EO0
	first character replacement	EO1afg
	second character replacement	EO2afg
	third character replacement	EO3afg
Address Stamping	disable reader address stamping	RU0
	enable reader address stamping	RU1
Address Delimiter	disable reader address delimiter	RV0
	enable reader address delimiter and select character	RV1h

a = ASCII character.

d = a number from the Hex/Numeric Table

e, f, g, h = HEX values representing an ASCII character

a = ASCII character of the DATALOGIC STANDARD Code Identifier from the table on page 52.

d = a number in the range **01-32** from the Hex/Numeric Table

e = Hex value from **00** to **FE**

f = Hex value of the character to be replaced from **00** to **FE**

g = Hex value of the new character to insert from **00** to **FE**

FF = replace with no new character (remove character)

h = a HEX value in the range from **00** - **FE** representing the ASCII character.

READING PARAMETERS		
DESCRIPTION		STRING
Hand-Held Operation	software trigger	BK0
	hardware trigger	BK1
	automatic	BK2
	always on	BK3
	hardware trigger ready	BK4
Stand Operation	software trigger	BU1
	hardware trigger	BU3
	automatic	BU0
	always on	BU2
Hardware Trigger Mode	trigger active level	BA0
	trigger active pulse	BA1
Trigger-off Timeout (s)		BD00 - BD99
FLASH ON (100 ms)		BB001 - BB099
FLASH OFF (100 ms)		BB101 - BB199
Reads per Cycle	one read	BC0
	multiple reads	BC1
Safety Time (100 ms)		BE00 - BE99
Beeper Intensity	very low intensity	BG0
	low intensity	BG1
	medium intensity	BG2
	high intensity	BG3
Beeper Tone	tone 1	BH0
	tone 2	BH1
	tone 3	BH2
	tone 4	BH3
Beeper Type	monotone	BJ0
	bitonal	BJ1
Beeper Length	long	BI0
	short	BI1
Stand Recognition Beep	disable	Ba0
	enable	Ba1

DECODING PARAMETERS		
DESCRIPTION		STRING
Ink-spread	disable	AX0
	enable	AX1
Overflow control	disable	AW1
	enable	AW0
Interdigit control	disable	AV0
	enable	AV1
Puzzle Solver™	disable	AU0
	enable	AU1
Decoding Safety	one read	ED0
	two reads	ED1
	three reads	ED2
	four reads	ED3

CODE SELECTION			
DESCRIPTION		STRING	
DISABLE ALL FAMILY CODES		AZ0	
EAN/UPC	disable EAN/UPC family	AA0	
	EAN 8/EAN 13/UPC A/UPC E	without ADD ON	AA1
		with ADD ON	AA5
	EAN 8/EAN 13	without ADD ON	AA3
		with ADD ON 2 ONLY	AAK
		with ADD ON 5 ONLY	AAL
		with ADD ON 2 AND 5	AA6
	UPC A/UPC E	without ADD ON	AA4
		with ADD ON 2 ONLY	AAM
		with ADD ON 5 ONLY	AAN
		with ADD ON 2 AND 5	AA7
	EAN/UPC with and without Add On no Autodiscrimination		AA8Ad0
	EAN/UPC Autodiscrimination Add On by Prefix		AA8Ad1
	Select Prefixes	cancel all selections	ET0
		378/379	ET1378ET2379
		434/439	ET3434ET4439
414/419		ET5414ET6419	
977		ET7977	
978		ET8978	
979		ET9979	
EAN 8 check digit transmission	Disable	AAG0	
	Enable	AAG1	
EAN 13 check digit transmission	disable	AAH0	
	enable	AAH1	
UPC A check digit transmission	disable	AAI0	
	enable	AAI1	

CODE SELECTION (continued)			
DESCRIPTION		STRING	
EAN/UPC	UPC E check digit transmission	disable	AAJ0
		enable	AAJ1
	conversions	UPC E to UPC A	AAA
		UPC E to EAN 13	AAB
		UPC A to EAN 13	AAC
		EAN 8 to EAN 13	AAD
	ISBN Conversion codes	enable ISBN	AP1
		enable ISSN	AP2
enable ISBN and ISSN		AP3	
disable ISBN and ISSN		AP0	
Code 39	disable Code 39 family		AB0
	Standard	no check digit control	AB11
		check digit control and transmission	AB12
		check digit control without transmission	AB13
	Full ASCII	no check digit control	AB21
		check digit control and transmission	AB22
		check digit control without transmission	AB23
	CIP 39		AB3
Code 32		AB4	
code length		AB*xxxx	
2/5	disable Code 2/5 family		AC0
	Interleaved 2/5	no check digit control	AC11xxxx
		check digit control and transmission	AC12xxxx
		check digit control without transmission	AC13xxxx
	Normal 2/5 5 bars	no check digit control	AC21xxxx
		check digit control and transmission	AC22xxxx
		check digit control without transmission	AC23xxxx
	Industrial 2/5 (IATA)	no check digit control	AC31xxxx
		check digit control and transmission	AC32xxxx
		check digit control without transmission	AC33xxxx
	Matrix 2/5 3 bars	no check digit control	AC41xxxx
		check digit control and transmission	AC42xxxx
		check digit control without transmission	AC43xxxx
CIP/HR		AC5	

xxxx = ASCII numbers that define the code length where:

- First 2 digits = minimum acceptable code length.
- Second 2 digits = maximum acceptable code length.

The minimum code length must always be less than or equal to the maximum.

The maximum code length for all codes is 99 characters:

Examples:

0132 = variable length from 1 to 32 digits in the code.

1010 = 10 digit code length only.

CODE SELECTION (continued)			
DESCRIPTION		STRING	
Codabar	disable Codabar family		AD0
	Standard	no start/stop character equality control nor transmission	AD111
		no start/stop character equality control but transmission	AD112
		start/stop character equality control but no transmission	AD121
		start/stop character equality control and transmission	AD122
	ABC Codabar	no start/stop character equality control but transmission	AD212
	Codabar ABC forced concatenation		AD232
	code length		AD*xxxx
start/stop character case in transmission	lower case	ADA0	
	upper case	ADA1	
Code 128	disable Code 128 family		A10
	enable Code 128 - control without transmission of check digit		A11
	enable EAN 128 - control without transmission of check digit		A121
	Transmit GS before Code	disable	EQ0
		enable	EQ1
	ISBT 128	enable ISBT 128	AI31
code length		AILxxxx	
Code 93	disable Code 93 family		AK0
	enable Code 93 - control without transmission of check digit		AK1
MSI	disable the family		AE0
	no check		AE1
	MOD10 no tx		AE2
	MOD10 with tx		AE3
	MOD11-MOD10 no tx		AE4
	MOD11-MOD10 with tx		AE5
	MOD10-MOD10 no tx		AE6
	MOD10-MOD10 with tx		AE7

xxxx = ASCII numbers that define the code length where:

- First 2 digits = minimum acceptable code length.
- Second 2 digits = maximum acceptable code length.

The minimum code length must always be less than or equal to the maximum.

The maximum code length for all codes is 99 characters:

EXAMPLES:

0132 = variable length from 1 to 32 digits in the code.

1010 = 10 digit code length only.

CODE SELECTION (continued)		
DESCRIPTION		STRING
Plessey	disable the family	AF0
	Standard no check	AF11
	Standard check - with tx	AF12
	Standard check - no tx	AF13
	Anker no check	AF21
	Anker check - with tx	AF22
	Anker check - no tx	AF23
Telepen	disable the family	AL0
	Numeric no check	AL11
	Numeric check - with tx	AL12
	Numeric check - no tx	AL13
	Alpha no check	AL21
	Alpha check - with tx	AL22
	Alpha check - no tx	AL23
Delta IBM	disable the family	AH0
	no check	AH1
	Type 1 check	AH2
	Type 2 check	AH3
Code 11	disable the family	AG0
	no check	AG1
	Type C with tx	AG21
	Type C no tx	AG22
	Type K with tx	AG31
	Type K no tx	AG32
	Type C and K with tx	AG41
	Type C and K no tx	AG42
Code 16K	disable	AJ0
	enable	AJ1
Code 49	disable	AM0
	enable	AM1
GS1 DataBar™	disable the family	AQ0
	disable RSS Expanded Linear and Stacked	AQ10
	enable RSS Expanded Linear and Stacked	AQ11
	disable RSS Limited	AQ20
	enable RSS Limited	AQ21
	disable RSS 14 Linear and Stacked	AQ30
	enable RSS 14 Linear and Stacked	AQ31

RADIO PARAMETERS		
DESCRIPTION		STRING
Radio Protocol Timeout	enable (seconds)	RH02-RH19
Power-Off Timeout		RP00-RP99
Beeper Control For Radio Response	normal	BF0
	only good decode	BF1
	only good reception	BF2
	off	BF3
Single Store	disable	RO0
	one attempt	RO1
	two attempts	RO2
	three attempts	RO3
	four attempts	RO4
	five attempts	RO5
	six attempts	RO6
	seven attempts	RO7
	eight attempts	RO8
nine attempts	RO9	
Batch Mode	disable	BZ0
	normal	BZ1
	automatic	BZ2

B CODE IDENTIFIER TABLE

2/5 Interleaved



2/5 Industrial



2/5 normal 5 bars



2/5 matrix 3 bars



EAN 8



EAN 13



UPC A



UPC E



EAN 8 with 2 ADD ON



EAN 8 with 5 ADD ON



EAN 13 with 2 ADD ON



EAN 13 with 5 ADD ON



UPC A with 2 ADD ON



UPC A with 5 ADD ON



UPC E with 2 ADD ON



UPC E with 5 ADD ON



Code 39



Code 39 Full ASCII



CODABAR



ABC CODABAR



Code 128



EAN 128



Code 93



CIP/39



CIP/HR



Code 32



ISBT 128



MSI



Plessey Standard



Telepen



Code 11



RSS Expanded Linear and Stacked



RSS 14 Linear and Stacked



Plessey Anker



Delta IBM



Code 16K



Code 49



RSS Limited



C HEX AND NUMERIC TABLE

CHARACTER TO HEX CONVERSION TABLE					
char	hex	char	hex	char	hex
NUL	00	*	2A	U	55
SOH	01	+	2B	V	56
STX	02	,	2C	W	57
ETX	03	-	2D	X	58
EOT	04	.	2E	Y	59
ENQ	05	/	2F	Z	5A
ACK	06	0	30	[5B
BEL	07	1	31	\	5C
BS	08	2	32]	5D
HT	09	3	33	^	5E
LF	0A	4	34	_	5F
VT	0B	5	35	`	60
FF	0C	6	36	a	61
CR	0D	7	37	b	62
SO	0E	8	38	c	63
SI	0F	9	39	d	64
DLE	10	:	3A	e	65
DC1	11	;	3B	f	66
DC2	12	<	3C	g	67
DC3	13	=	3D	h	68
DC4	14	>	3E	i	69
NAK	15	?	3F	j	6A
SYN	16	@	40	k	6B
ETB	17	A	41	l	6C
CAN	18	B	42	m	6D
EM	19	C	43	n	6E
SUB	1A	D	44	o	6F
ESC	1B	E	45	p	70
FS	1C	F	46	q	71
GS	1D	G	47	r	72
RS	1E	H	48	s	73
US	1F	I	49	t	74
SPACE	20	J	4A	u	75
!	21	K	4B	v	76
"	22	L	4C	w	77
#	23	M	4D	x	78
\$	24	N	4E	y	79
%	25	O	4F	z	7A
&	26	P	50	{	7B
'	27	Q	51		7C
(28	R	52	}	7D
)	29	S	53	~	7E
		T	54	DEL	7F

CHARACTER TO HEX CONVERSION TABLE					
char	hex	char	hex	char	hex
€	80	ª	AA	Õ	D5
□	81	«	AB	Ö	D6
,	82	¬	AC	×	D7
ENTER	83	-	AD	Ø	D8
TAB	84	®	AE	Ù	D9
F1	85	-	AF	Ú	DA
F2	86	°	B0	Û	DB
F3	87	±	B1	Ü	DC
F4	88	²	B2	Ý	DD
F5	89	³	B3	þ	DE
F6	8A	´	B4	ß	DF
F7	8B	µ	B5	à	E0
F8	8C	¶	B6	á	E1
F9	8D	·	B7	â	E2
F10	8E	¸	B8	ã	E3
F11	8F	¹	B9	ä	E4
F12	90	º	BA	å	E5
HOME	91	»	BB	æ	E6
END	92	¼	BC	ç	E7
Pg UP	93	½	BD	è	E8
Pg Down	94	¾	BE	é	E9
↑	95	¿	BF	ê	EA
↓	96	À	C0	ë	EB
←	97	Á	C1	ì	EC
→	98	Â	C2	í	ED
ESC	99	Ã	C3	î	EE
CTRL(Right)	9A	Ä	C4	ï	EF
€	9B	Å	C5	ð	F0
œ	9C	Æ	C6	ñ	F1
□	9D	Ç	C7	ò	F2
ž	9E	È	C8	ó	F3
ÿ	9F	É	C9	ô	F4
NBSP	A0	Ê	CA	õ	F5
ı	A1	Ë	CB	ö	F6
ç	A2	Ì	CC	÷	F7
£	A3	Í	CD	ø	F8
¤	A4	Î	CE	ù	F9
¥	A5	Ï	CF	ú	FA
¦	A6	Ð	D0	û	FB
§	A7	Ñ	D1	ü	FC
¨	A8	Ò	D2	ý	FD
©	A9	Ó	D3	Reserved	FE
		Ô	D4	Reserved	FF

HEX / NUMERIC TABLE



0



2



4



6



8



A



C



E



1



3



5



7



9



B



D



F

Backspace



Cancels an incomplete configuration sequence

Datalogic Scanning, Inc.
959 Terry Street
Eugene, OR 97402
USA



dichiara che
declares that the
déclare que le
bescheinigt, daß das Gerät
declare que el

QUICKSCAN M21XX Kit 433Mhz; Cordless System

e tutti i suoi modelli
and all its models
et tous ses modèles
und seine Modelle
y todos sus modelos

sono conformi alla Direttiva del Consiglio Europeo sottoelencata:
are in conformity with the requirements of the European Council Directive listed below:
sont conformes aux spécifications de la Directive de l'Union Européenne ci-dessous:
den nachstehenden angeführten Direktive des Europäischen Rats entsprechen:
cumple con los requisitos de la Directiva del Consejo Europeo, según la lista siguiente:

1999/5/EEC R&TTE

Questa dichiarazione è basata sulla conformità dei prodotti alle norme seguenti:
This declaration is based upon compliance of the products to the following standards:
Cette déclaration repose sur la conformité des produits aux normes suivantes:
Diese Erklärung basiert darauf, daß das Produkt den folgenden Normen entspricht:
Esta declaración se basa en el cumplimiento de los productos con las siguientes normas:

**ETSI EN 301 489-3 V1.4.1,
AUGUST 2002 :**

*ELECTROMAGNETIC COMPATIBILITY AND RADIO SPECTRUM MATTERS (ERM);
ELECTROMAGNETIC COMPATIBILITY (EMC) STANDARD FOR RADIO
EQUIPMENT AND SERVICES;
PART 3: SPECIFIC CONDITIONS FOR SHORT-RANGE DEVICES (SRD)
OPERATING ON FREQUENCIES BETWEEN 9KHZ AND 40GHZ*

**ETSI EN 300 220-3 V1.1.1,
SEPTEMBER 2000 :**

*ELECTROMAGNETIC COMPATIBILITY AND RADIO SPECTRUM
MATTERS (ERM); SHORT RANGE DEVICES (SRD); RADIO
EQUIPMENT TO BE USED IN THE 25MHZ TO 1000MHZ
FREQUENCY RANGE WITH POWER LEVELS RANGING UP TO
500MW; PART 3: HARMONIZED EN COVERING ESSENTIAL
REQUIREMENTS UNDER ARTICLE 3.2 OF THE R&TTE DIRECTIVE*

EN 60950-1, DECEMBER 2001 :

*INFORMATION TECHNOLOGY EQUIPMENT - SAFETY -
PART 1 : GENERAL REQUIREMENTS*

March 1st, 2007

Australia

Datalogic Scanning Pty Ltd
Telephone: [61] (2) 9870 3200
australia.scanning@datalogic.com

Japan

Datalogic Scanning KK
Telephone: 81 (0)3 3491 6761
japan.scanning@datalogic.com

France and Benelux

Datalogic Scanning Sarl
Telephone: [33].01.64.86.71.00
france.scanning@datalogic.com

Latin America

Datalogic Scanning, Inc
Telephone: (305) 591-3222
latinamerica.scanning@datalogic.com

Germany

Datalogic Scanning GmbH
Telephone: 49 (0) 61 51/93 58-0
germany.scanning@datalogic.com

Singapore

Datalogic Scanning Singapore PTE LTD
Telephone: (65) 6435-1311
singapore.scanning@datalogic.com

India

Datalogic Scanning India
Telephone: 91- 22 - 64504739
india.scanning@datalogic.com

Spain and Portugal

Datalogic Scanning Sarl Sucursal en España
Telephone: 34 91 746 28 60
spain.scanning@datalogic.com

Italy

Datalogic Scanning SpA
Telephone: [39] (0) 39/62903.1
italy.scanning@datalogic.com

United Kingdom

Datalogic Scanning LTD
Telephone: 44 (0) 1923 809500
uk.scanning@datalogic.com

Kontakt:

Drucksysteme Janz & Raschke GmbH
Osterbrooksweg 71, D-22869 Schenefeld
Tel.: +49(0)40 - 840 509 0
Fax: +49(0)40 - 840 509 29
Email: kontakt@jrdrucksysteme.de
www.jrdrucksysteme.de

DATALOGIC™

www.scanning.datalogic.com

Datalogic Scanning, Inc.

959 Terry Street
Eugene, OR 97402
Telephone: (541) 683-5700
Fax: (541) 345-7140

